

2021



Guttormsgaards ARKIV

einprekanta
+prekanta

K. G.



A

vandalist

COLORING

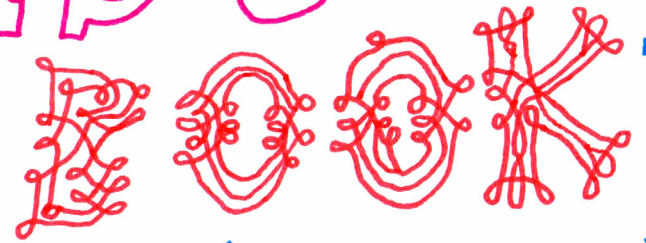

<https://vandal.ist/arabesque>

INSTITUTE FOR COMPUTATIONAL VANDALISM

THE MOVEMENT INTO THE IMAGE

IS, FOR ME,

PRECISELY THE SAME AS TRAVELLING OUT
INTO THE WORLD.

IT IS A QUESTION OF

SEEING THROUGH THE CONVENTIONS,

OF SEEING ONE'S OWN CULTURE

FROM THE OUTSIDE —

OR OF TRYING TO GO AS FAR AS POSSIBLE
INTO IT.

GUTTORM GUTTORMSGAARD

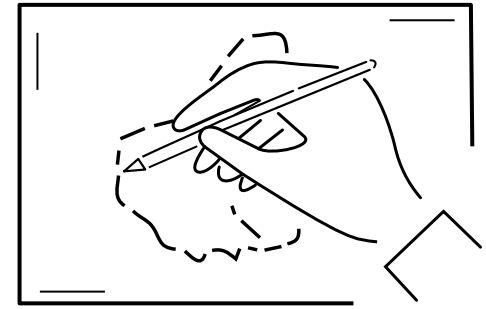
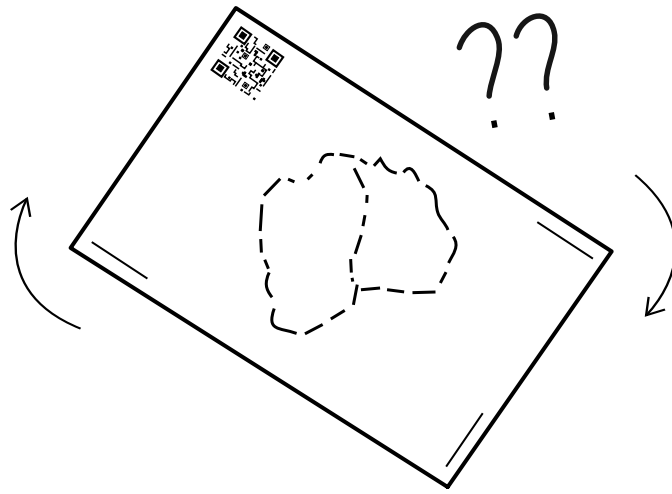
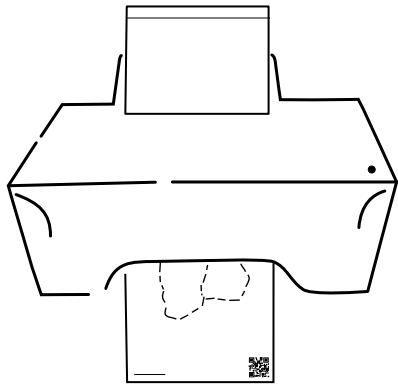

**vandal.ist/
arabesque**

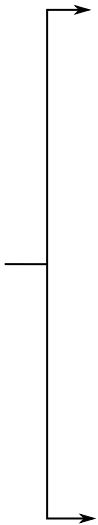
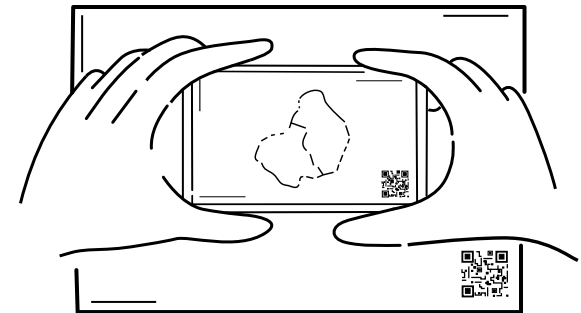
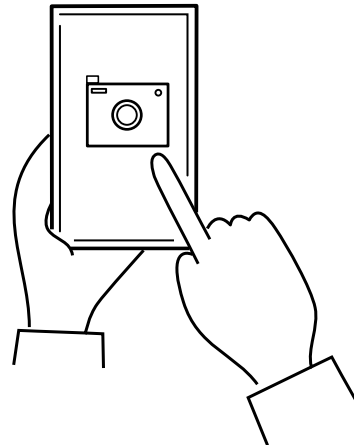
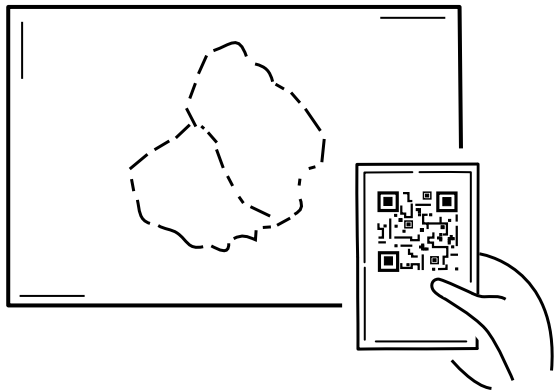
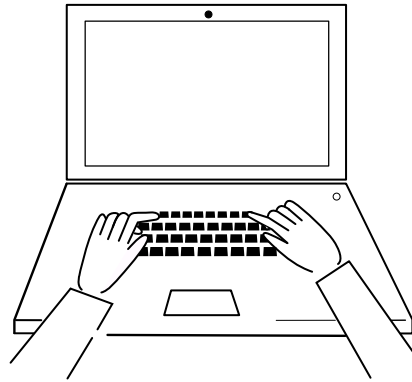
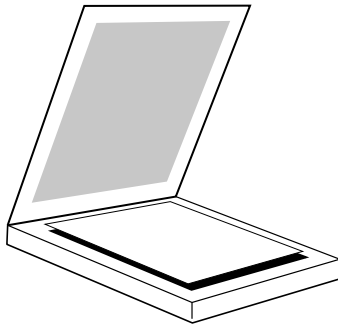



Is it a bush? (11.2%)



Is it a bush? (8.5%)

Is it a bush? (13.7%)

Is it a bush? (16.7%)



Is it a keyboard? (36.0%)

Is it a keyboard? (16.4%)

Is it a keyboard? (21.1%)

Is it a keyboard? (17.7%)



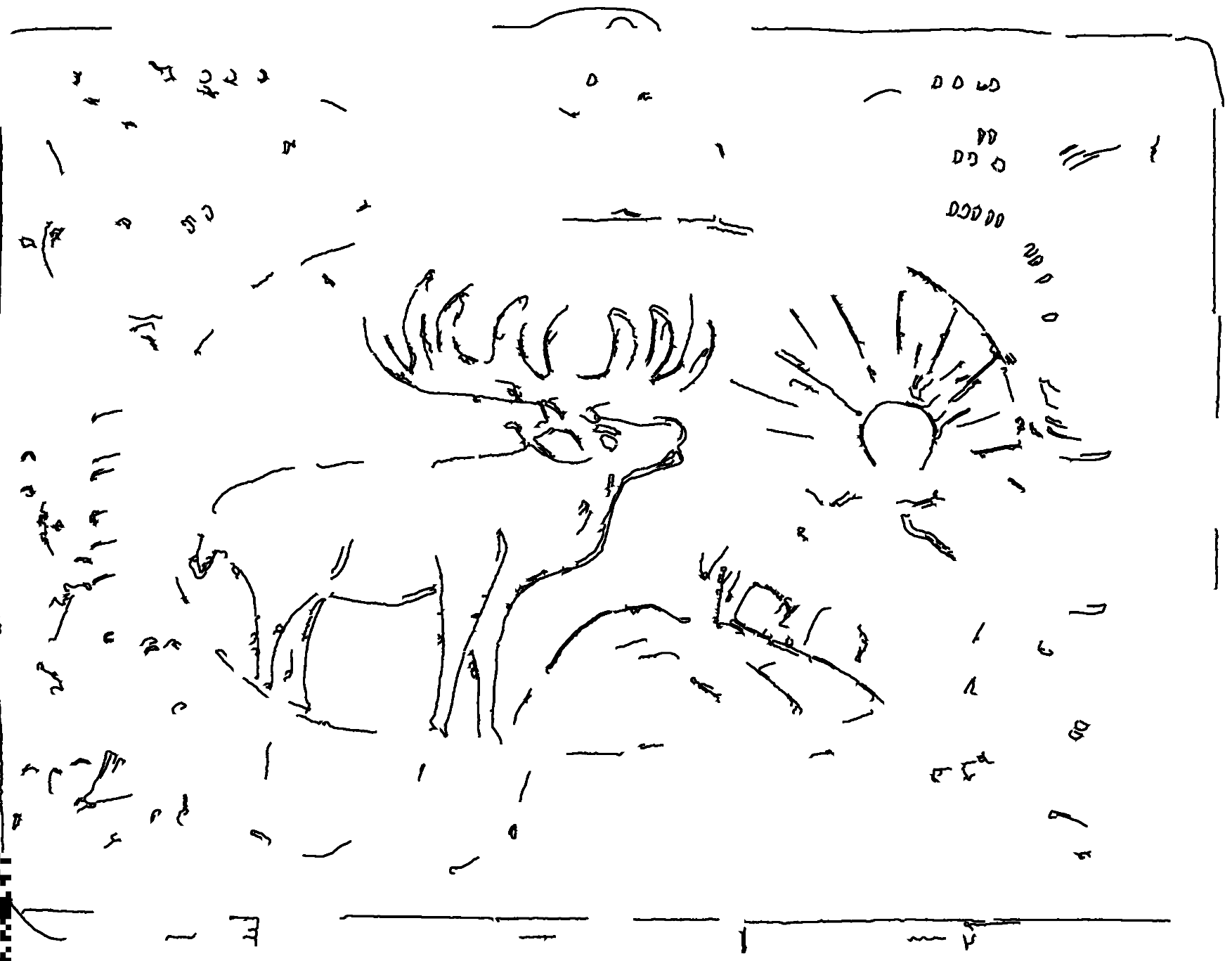

Is it a keyboard? (10.9%)

Is it a keyboard? (11.7%)

Is it a keyboard? (9.8%)

Is it a keyboard? (8.3%)





Is it a bush? (8.8%)

Is it a grapes? (6.6%)



Is it a grapes? (9.3%)

Is it a bush? (9.2%)

Is it a keyboard? (14.8%)

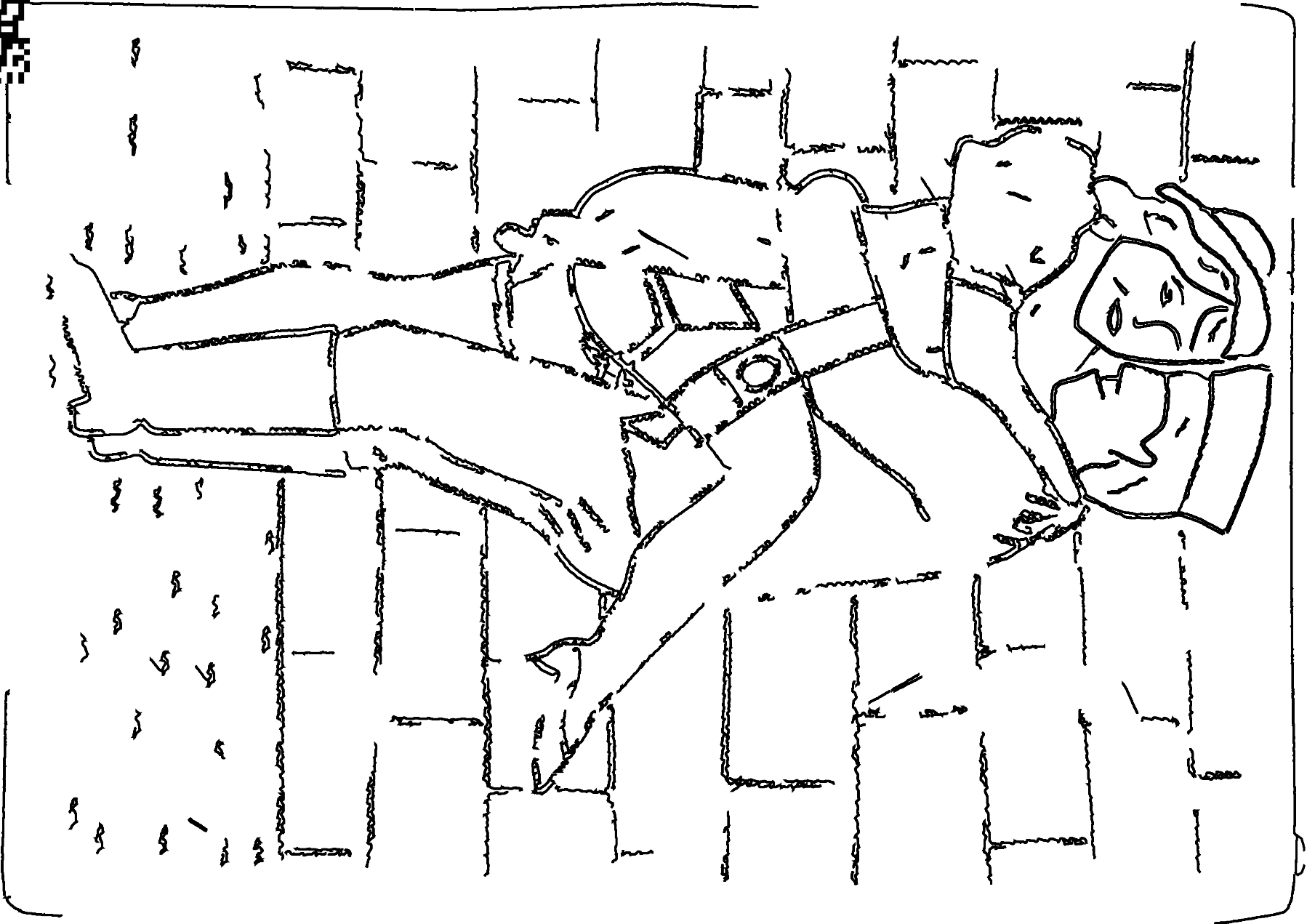

Is it a skyscraper? (21.6%)

Is it a chandelier? (13.5%)

Is it a skyscraper? (15.9%)

Is it a keyboard? (9.8%)



Is it a keyboard? (18.8%)



Is it a keyboard? (19.6%)

Is it a keyboard? (10.8%)

Is it a keyboard? (18.0%)

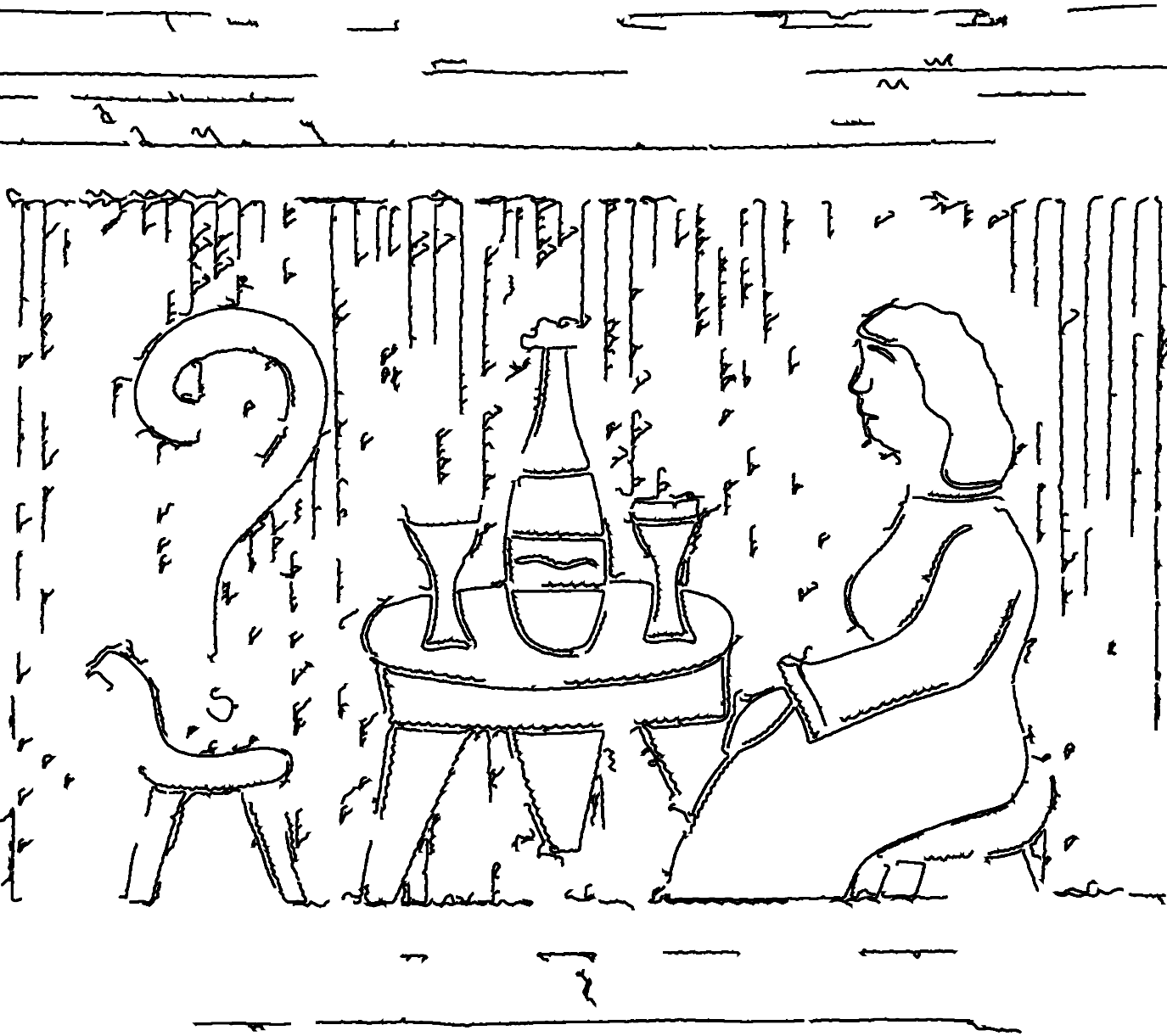

Is it a keyboard? (14.6%)



Is it a keyboard? (19.1%)

Is it a keyboard? (24.0%)

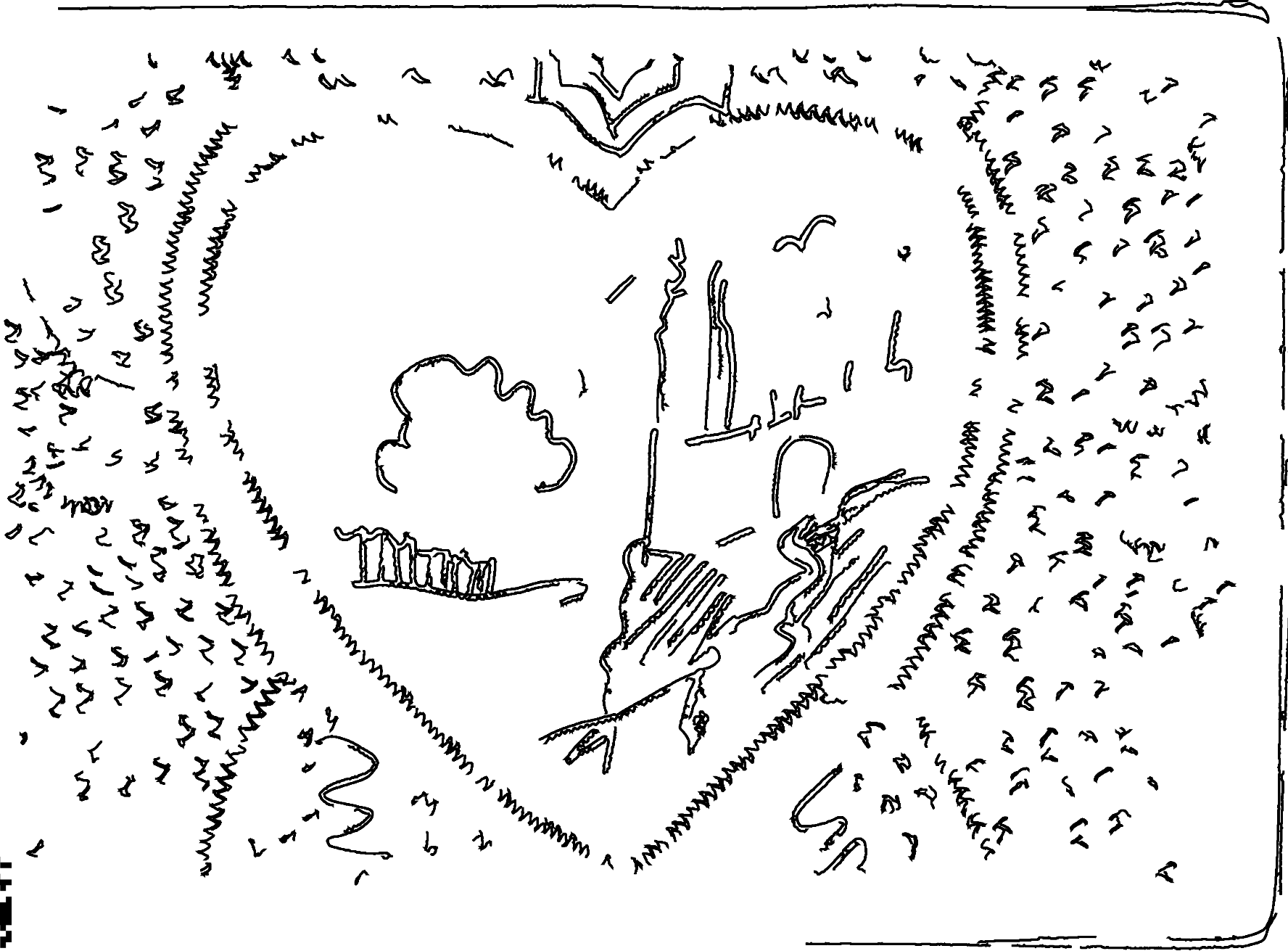

Is it a keyboard? (47.5%)



Is it a keyboard? (38.4%)

Is it a keyboard? (39.6%)

Is it a keyboard? (50.7%)

Is it a grapes? (7.4%)

Is it a moon? (6.9%)

Is it a cake? (9.1%)

Is it a huge pile of...

Is it a moon? (5.9%)





Is it a bush? (17.1%)



Is it a grapes? (10.5%)

Is it a grapes? (13.8%)

Is it a skyscraper? (4.0%)

Is it a grapes? (21.1%)

Is it a chandelier? (27.3%)

OSLO



1943



Is it a moon? (10.5%)

Is it a grapes? (13.7%)

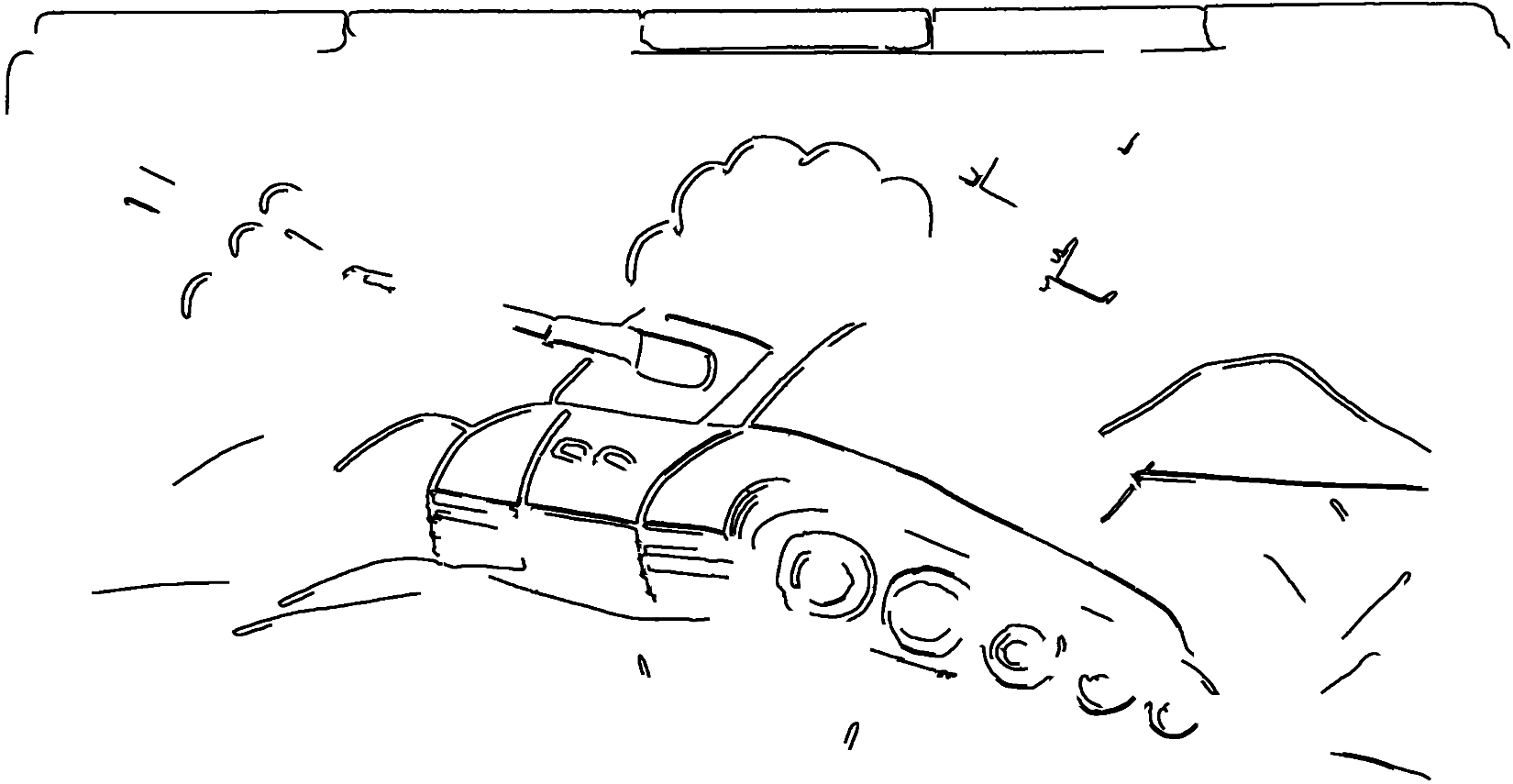

Is it a chandelier? (15.9%)



Is it a chandelier? (6.3%)

Is it a chandelier? (10.6%)

Is it a skyscraper? (9.5%)

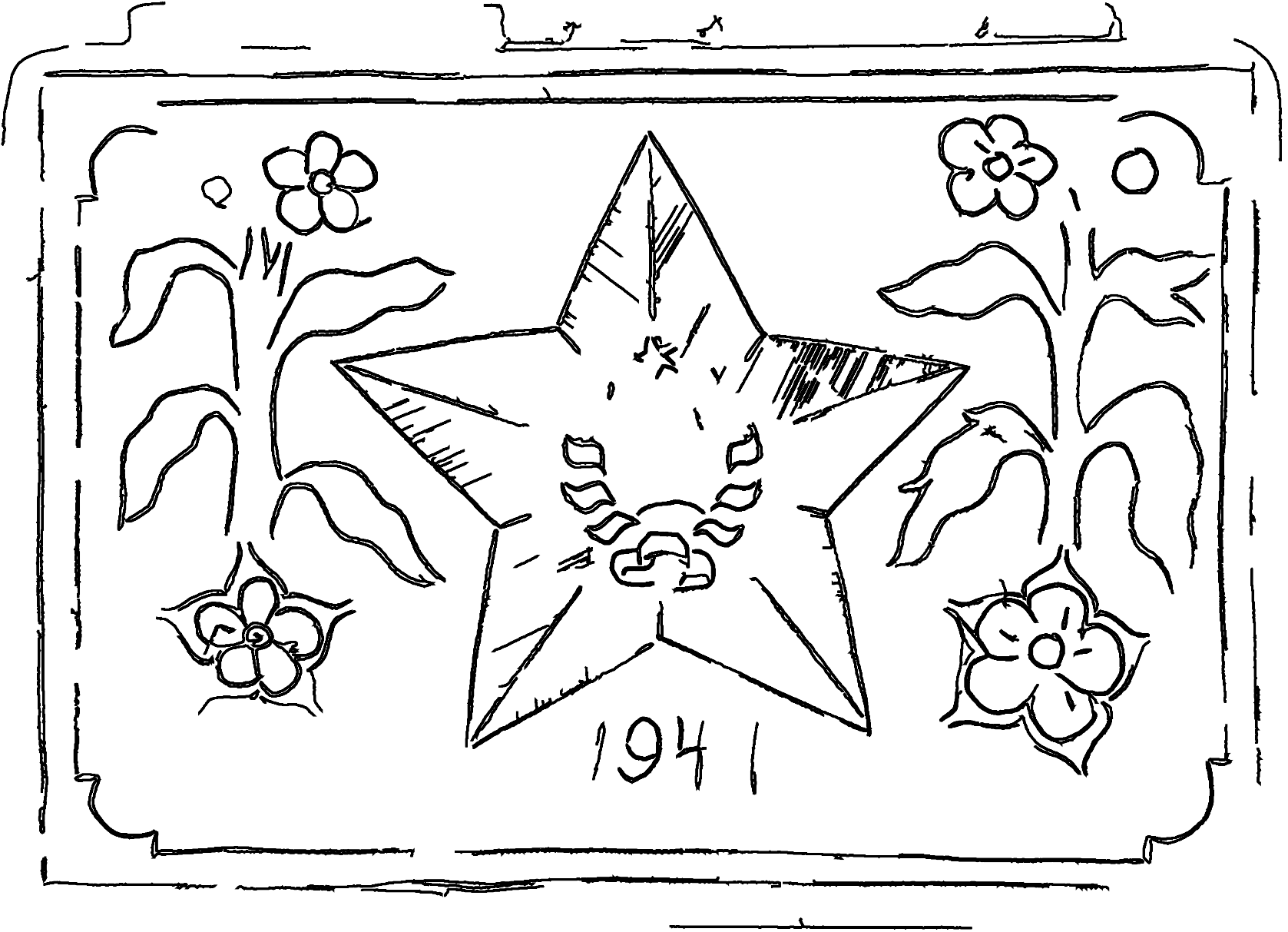

Is it a keyboard? (22.1%)



Is it a keyboard? (68.0%)

Is it a keyboard? (28.5%)

Is it a keyboard? (70.3%)

Is it a moon? (6.6%)



Is it a bush? (8.7%)



Is it a bush? (8.6%)

Is it a bush? (9.3%)

Is it a cactus? (42.8%)

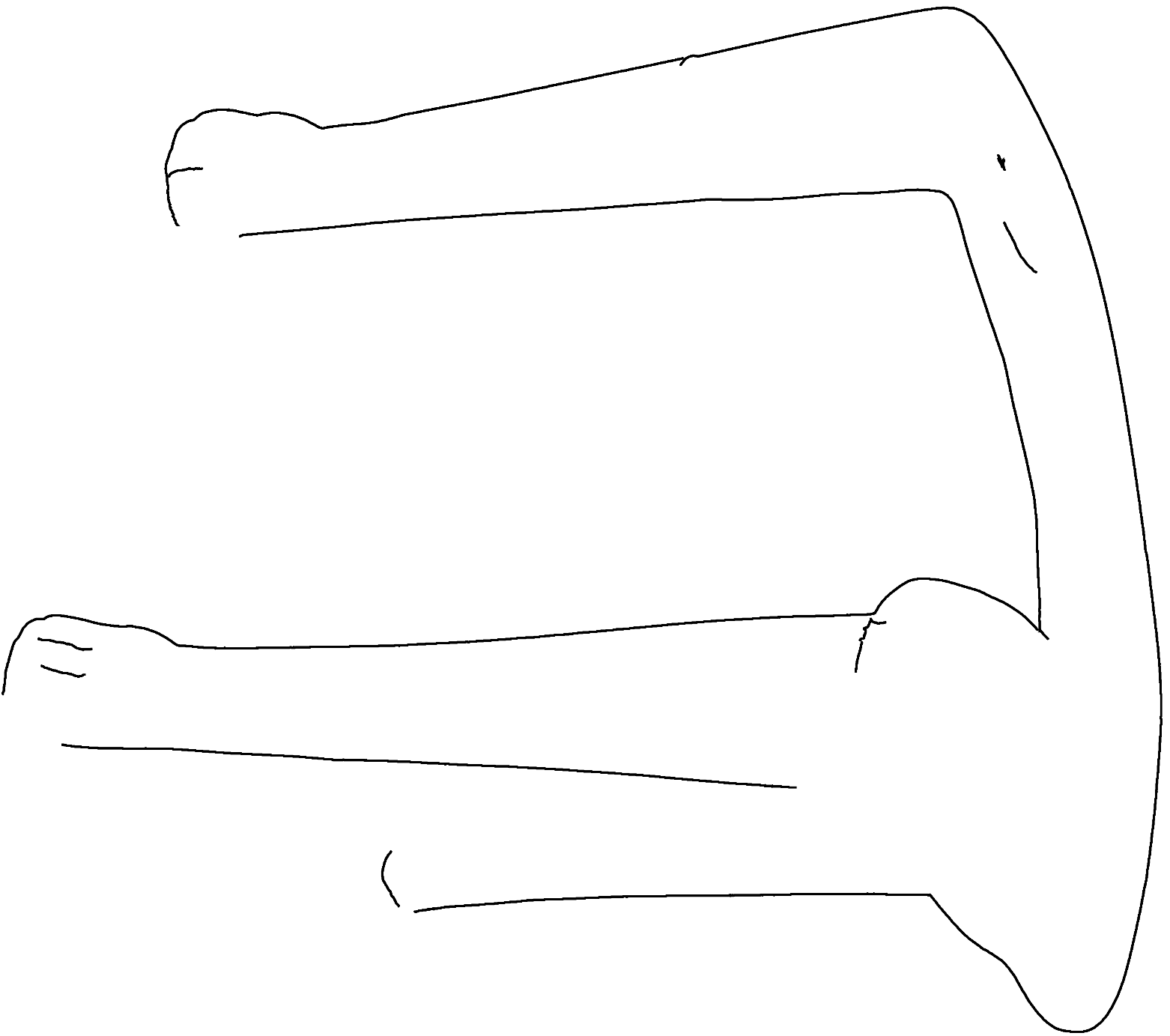

Is it a streetlight? (11.7%)



Is it a skyscraper? (9.1%)

Is it a cactus? (32.9%)

Is it a keyboard? (48.3%)

Is it a skyscraper? (22.1%)

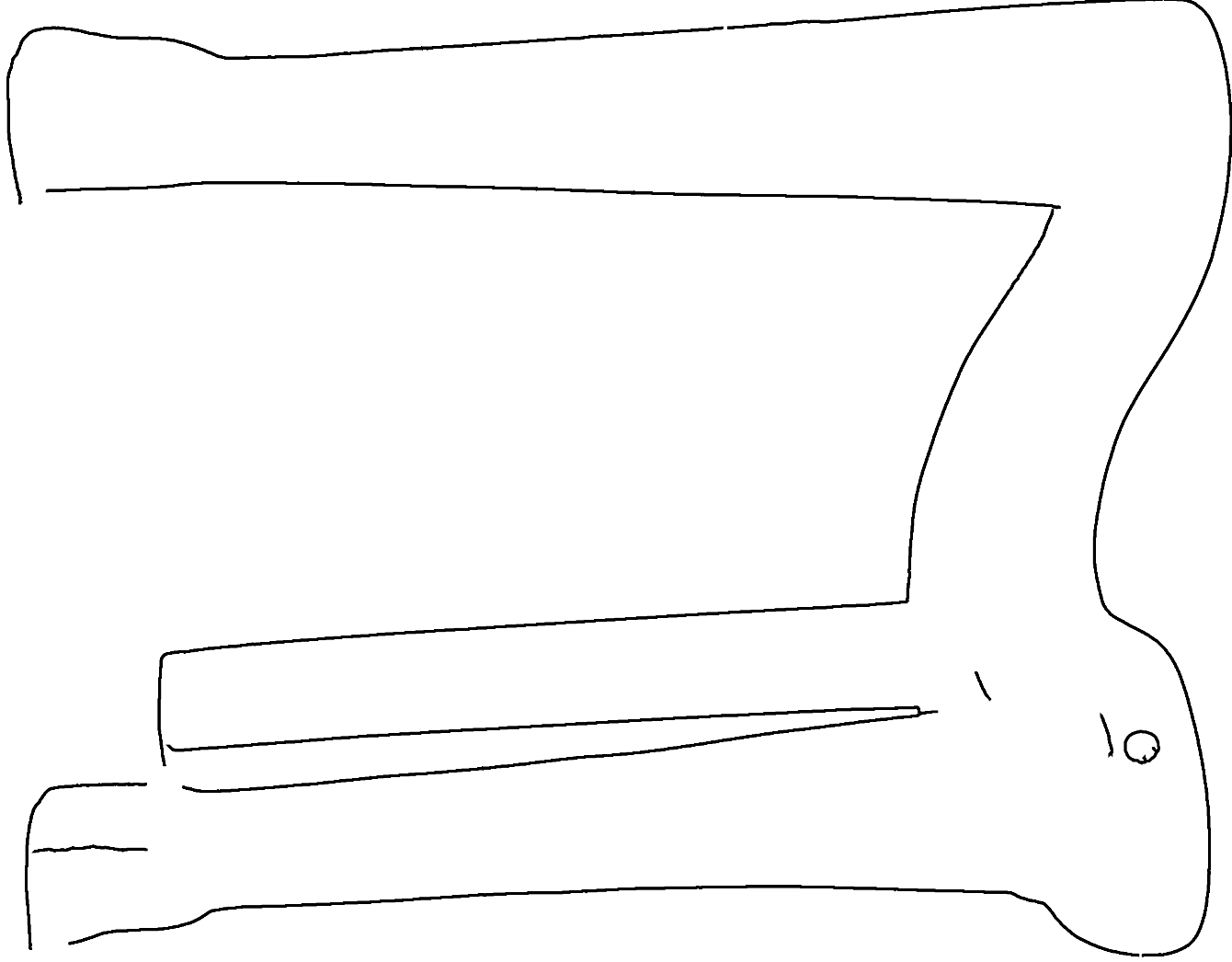

Is it a skyscraper? (20.8%)

Is it a cactus? (70.6%)



Is it a bush? (16.5%)

Is it a telephone? (32.6%)



Is it a saxophone? (11.0%)

Is it a telephone? (9.6%)

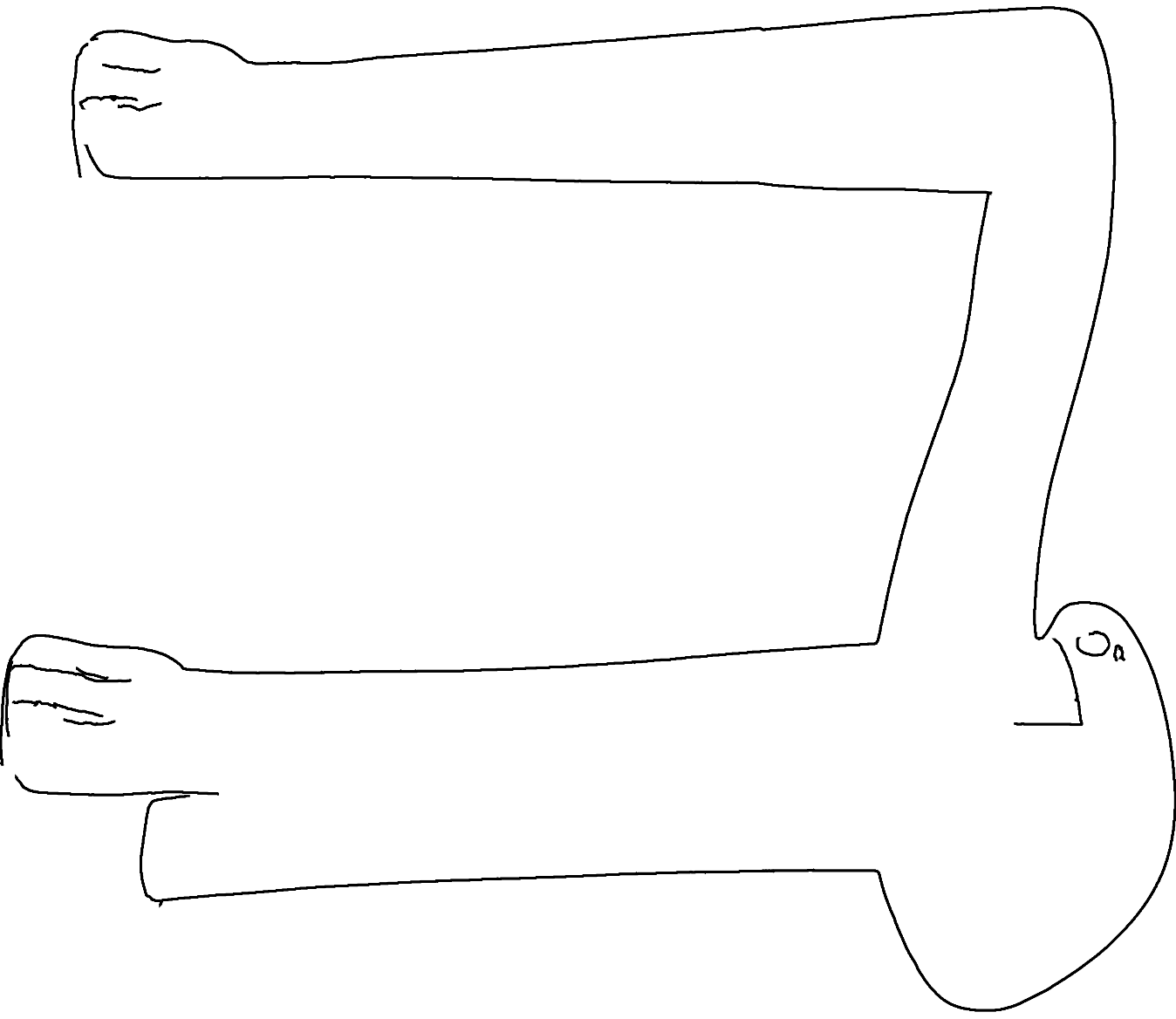

Is it a skyscraper? (74.4%)

Is it a cactus? (53.0%)



Is it a skyscraper? (24.6%)

Is it a crocodile? (17.5%)

Is it a grapes? (6.6%)



Is it a bush? (11.4%)



Is it a grapes? (9.9%)

Is it a bush? (7.9%)



Is it a rifle? (3.2%)

Is it a rifle? (3.0%)



Is it a rifle? (2.7%)

Is it a syringe? (3.0%)

Is it a grapes? (31.2%)

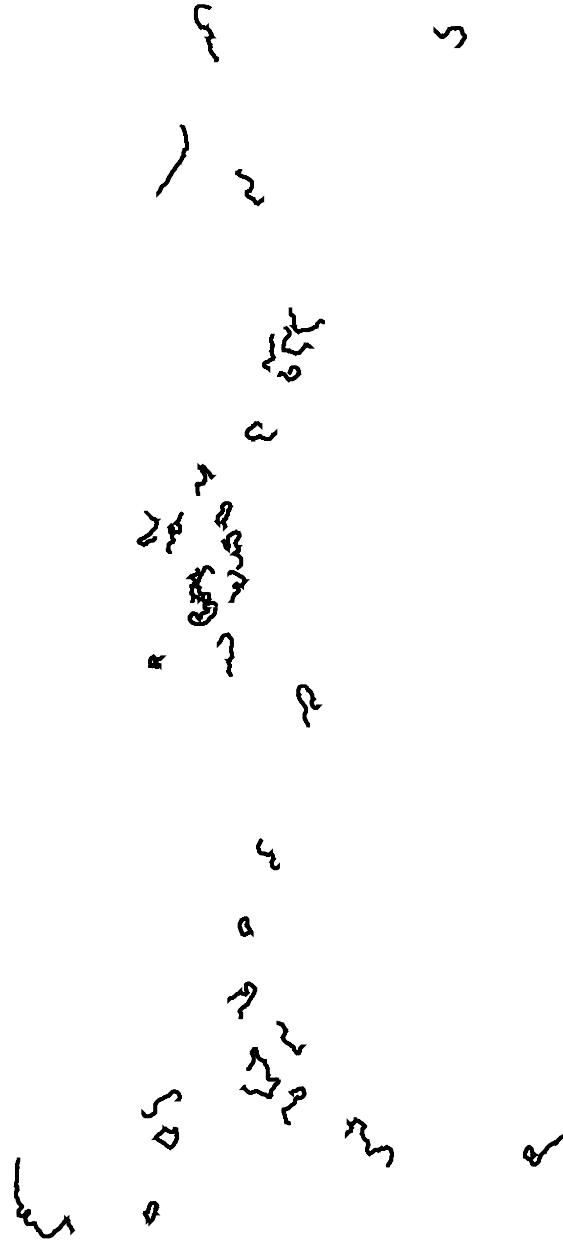

Is it a flying-saucer? (3.1%)

Is it a grapes? (16.7%)



Is it a grapes? (2.8%)



Is it a bush? (90.0%)

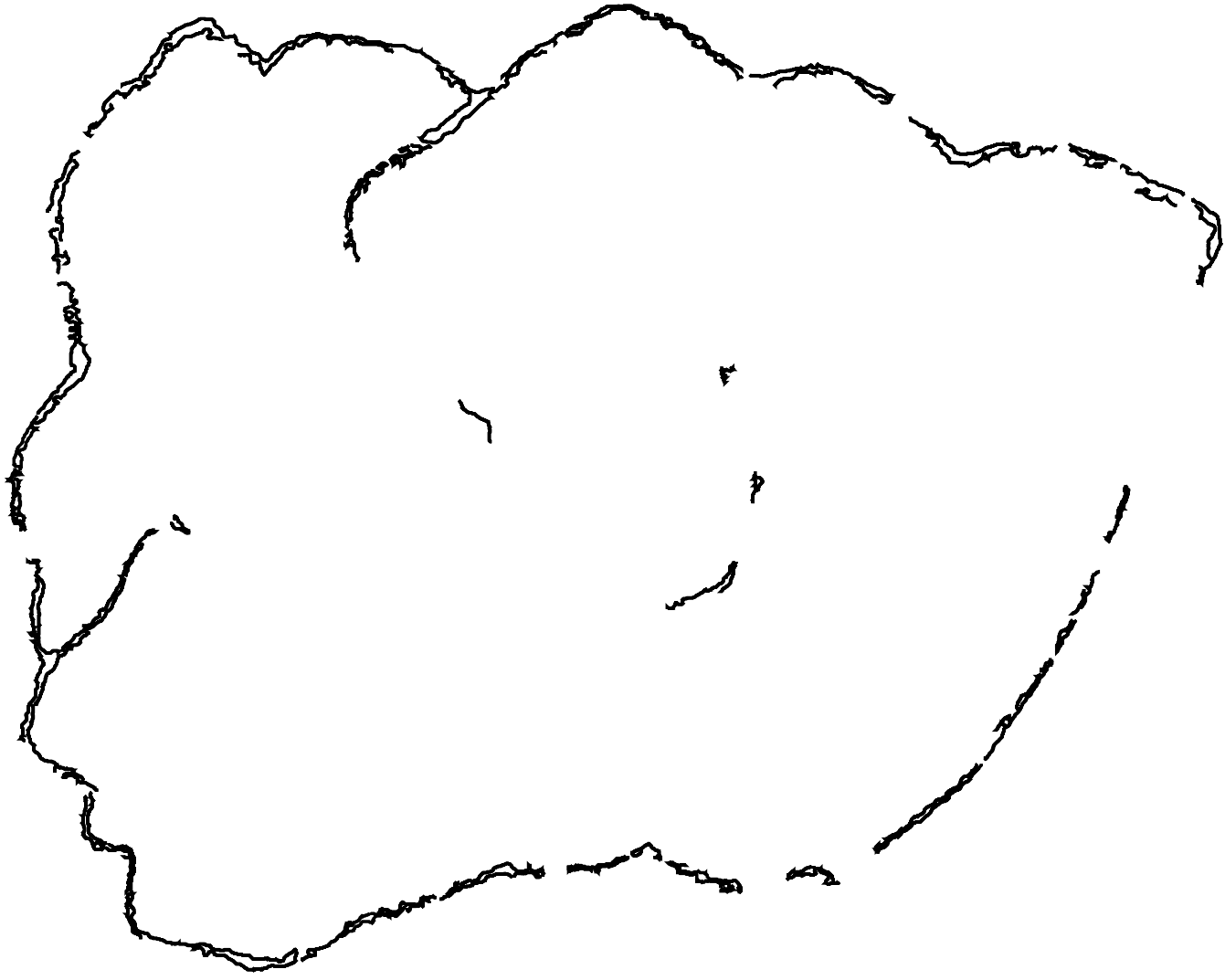

Is it a bush? (79.1%)

Is it a bush? (69.0%)

Is it a bush? (60.3%)



Is it a bush? (21.7%)



Is it a bush? (45.7%)

Is it a bush? (32.2%)

Is it a bush? (59.2%)

Is it a bush? (8.2%)



Is it a grapes? (6.7%)



Is it a chandelier? (4.8%)

Is it a chandelier? (7.8%)

Is it a chandelier? (4.4%)



Is it a bush? (11.4%)

Is it a bush? (13.2%)



Is it a bush? (34.3%)

Is it a bush? (48.2%)



Is it a bush? (82.8%)

Is it a bush? (41.4%)



Is it a bush? (83.3%)



Is it a grapes? (29.4%)

Is it a chandelier? (12.4%)

Is it a chandelier? (12.4%)

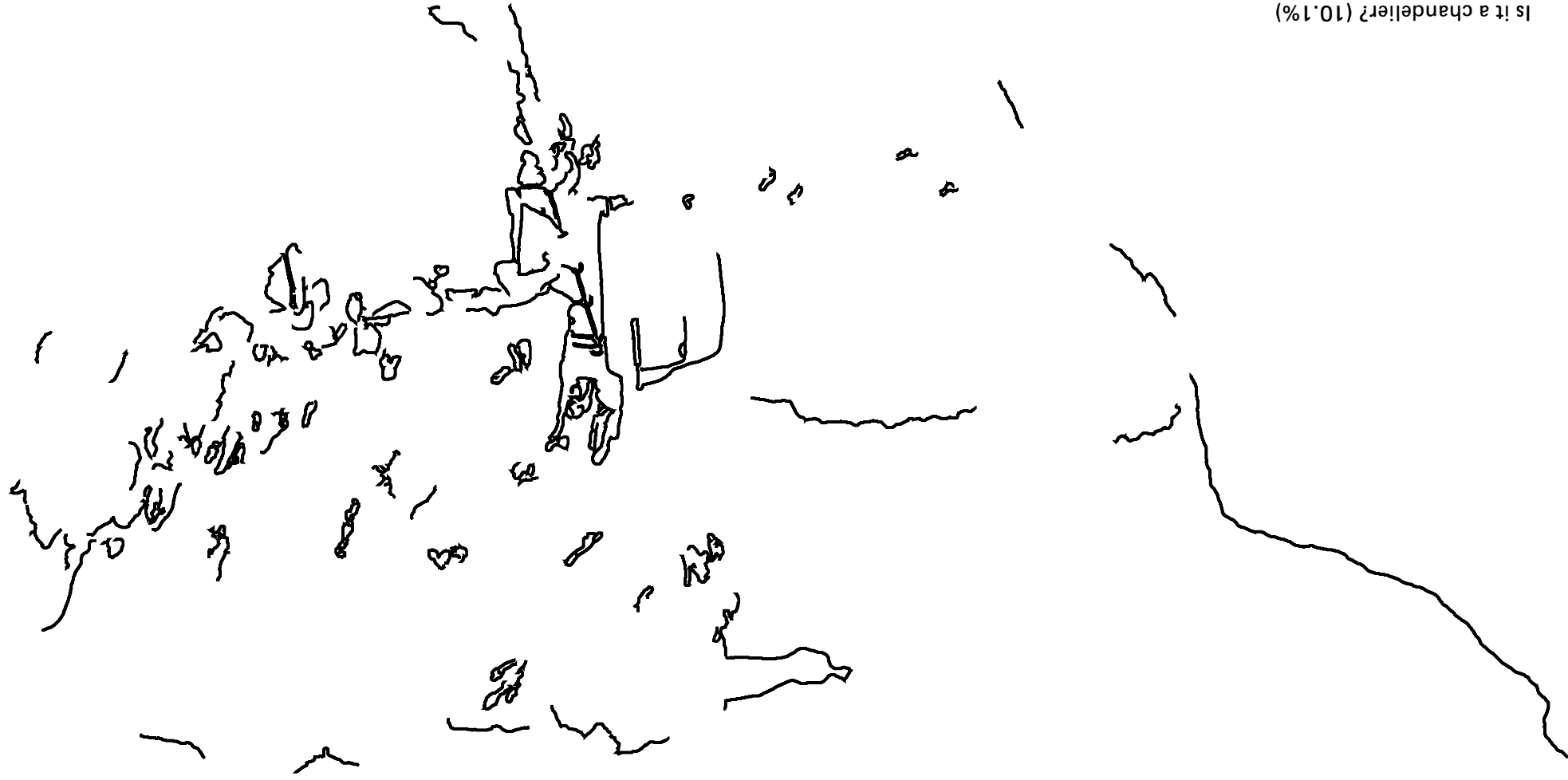

Is it a chandelier? (10.1%)

Is it a chandelier? (8.1%)

Is it a grapes? (8.5%)

Is it a bush? (10.5%)



Is it a bush? (8.7%)

Is it a chandelier? (7.9%)



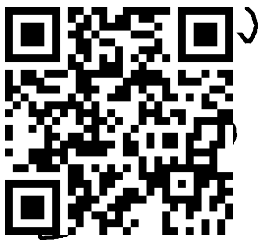

Is it a moon? (6.4%)



Is it a moon? (11.6%)

Stacy



Is it a moon? (15.5%)

Is it a moon? (7.2%)

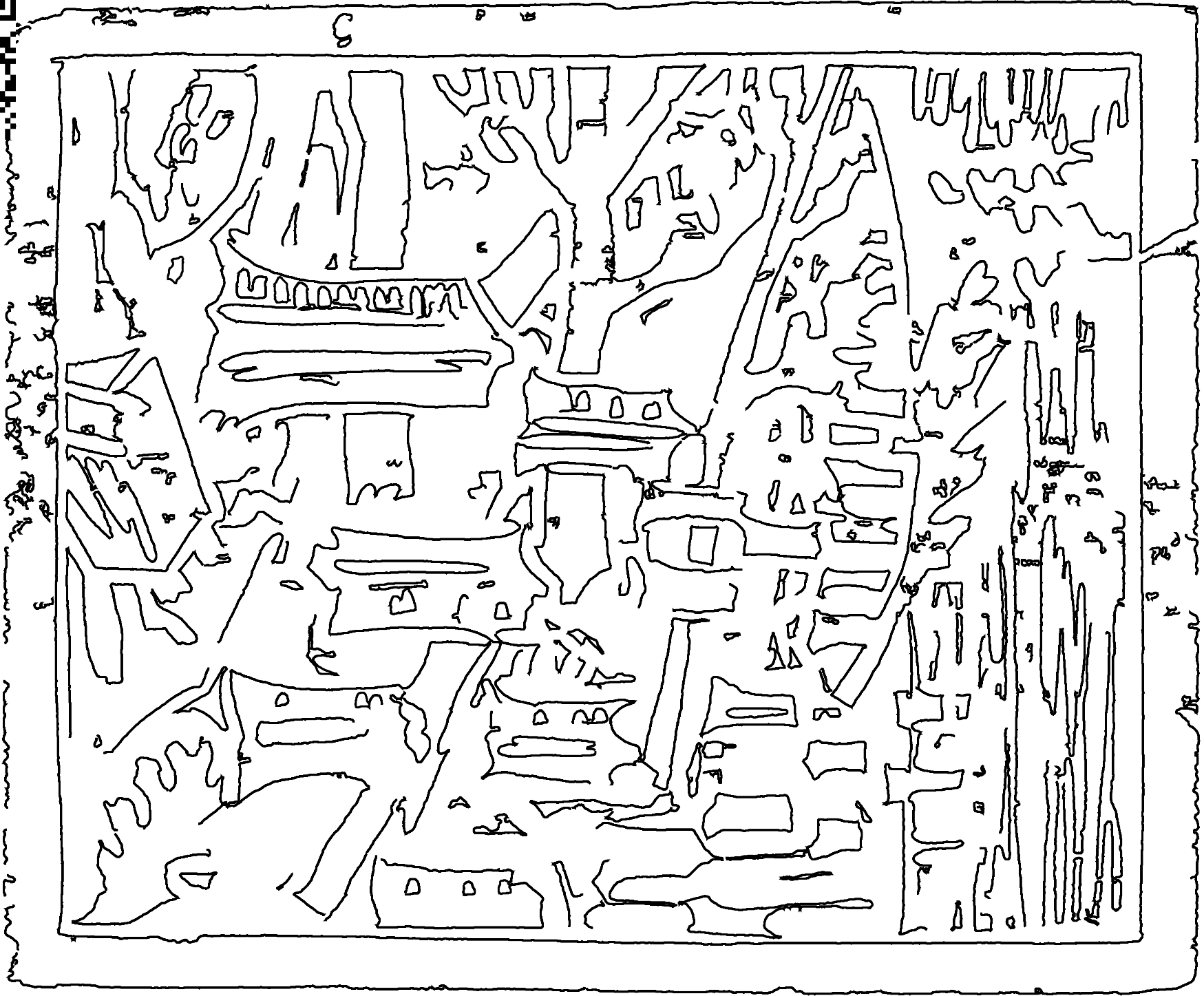

Is it a keyboard? (81.0%)

Is it a keyboard? (56.7%)



Is it a keyboard? (71.7%)

Is it a keyboard? (57.3%)

Is it a bush? (24.3%)



Is it a skyscraper? (28.0%)

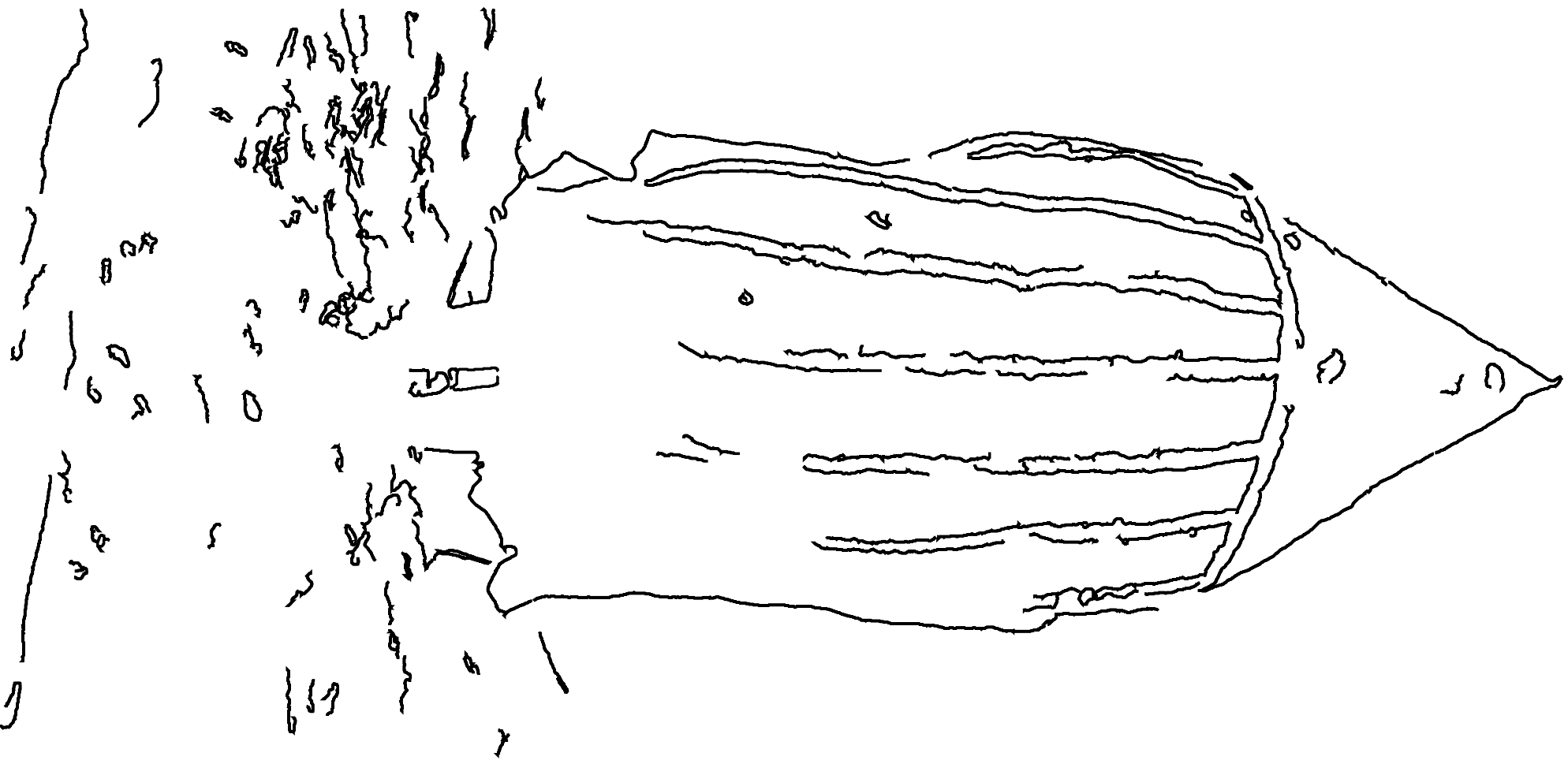

Is it a bush? (24.0%)

Is it a strawberry? (88.3%)

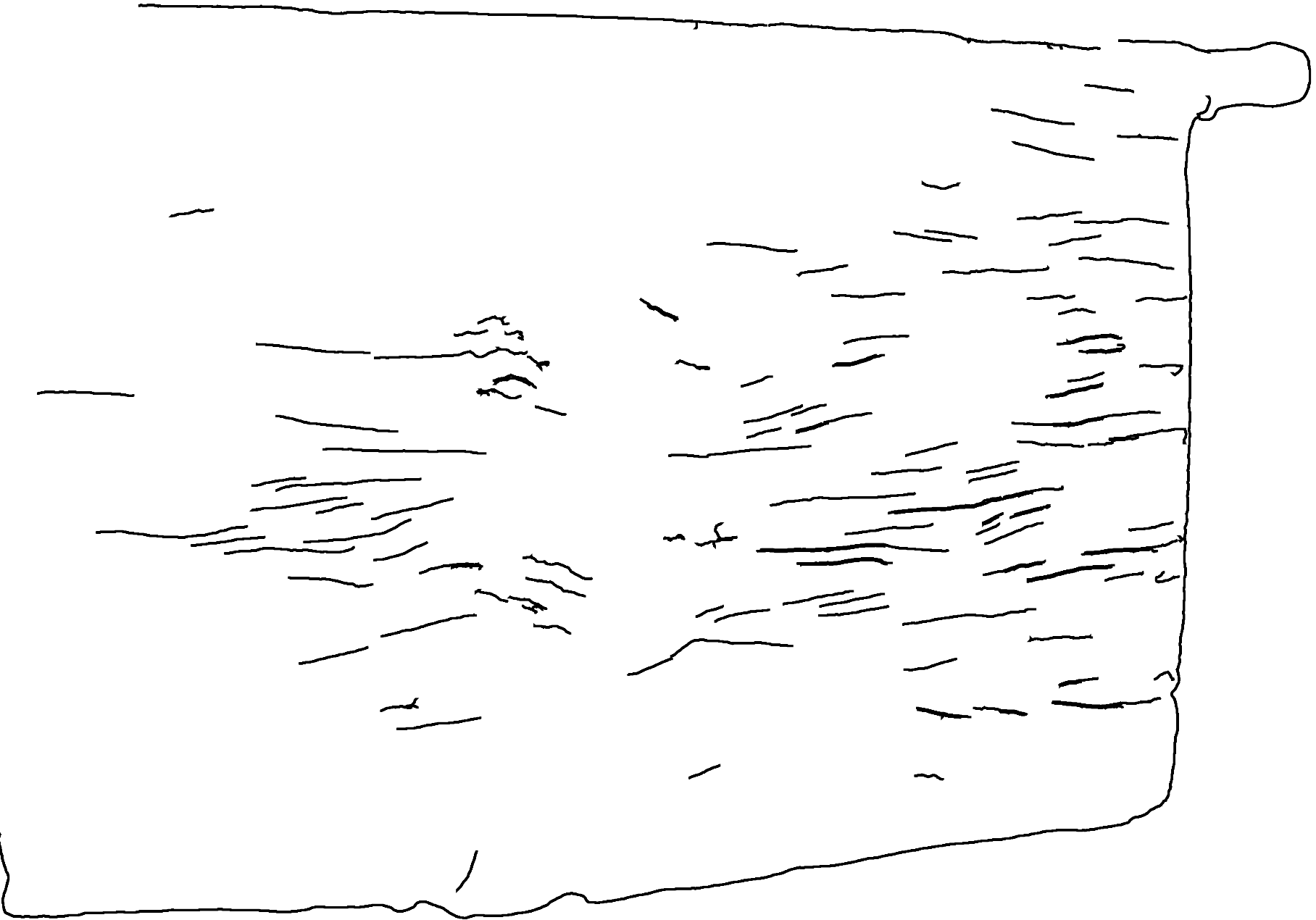

Is it a cactus? (10.1%)



Is it a bush? (16.4%)

Is it a keyboard? (5.3%)

Is it a keyboard? (26.7%)



Is it a grapes? (15.5%)

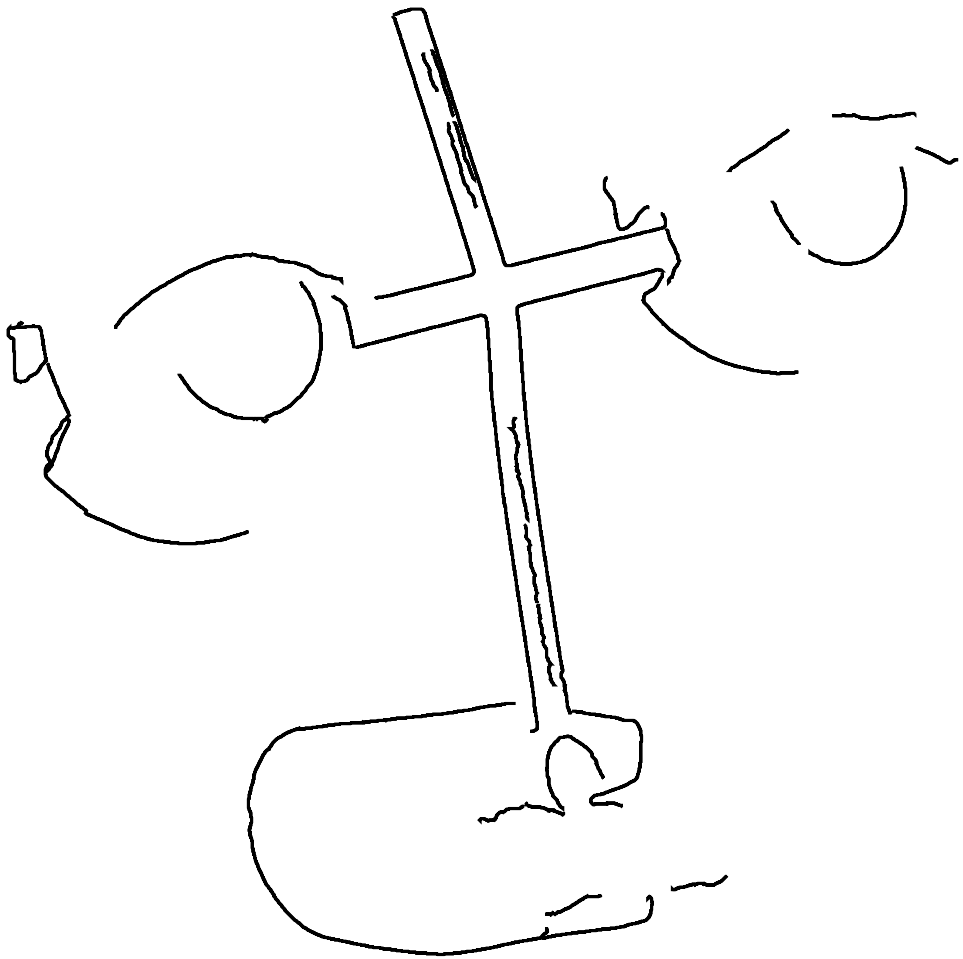

Is it a grapes? (3.3%)

Is it a bush? (4.0%)

Is it a bush? (2.9%)

Is it a grapes? (8.5%)

Is it a bush? (6.7%)

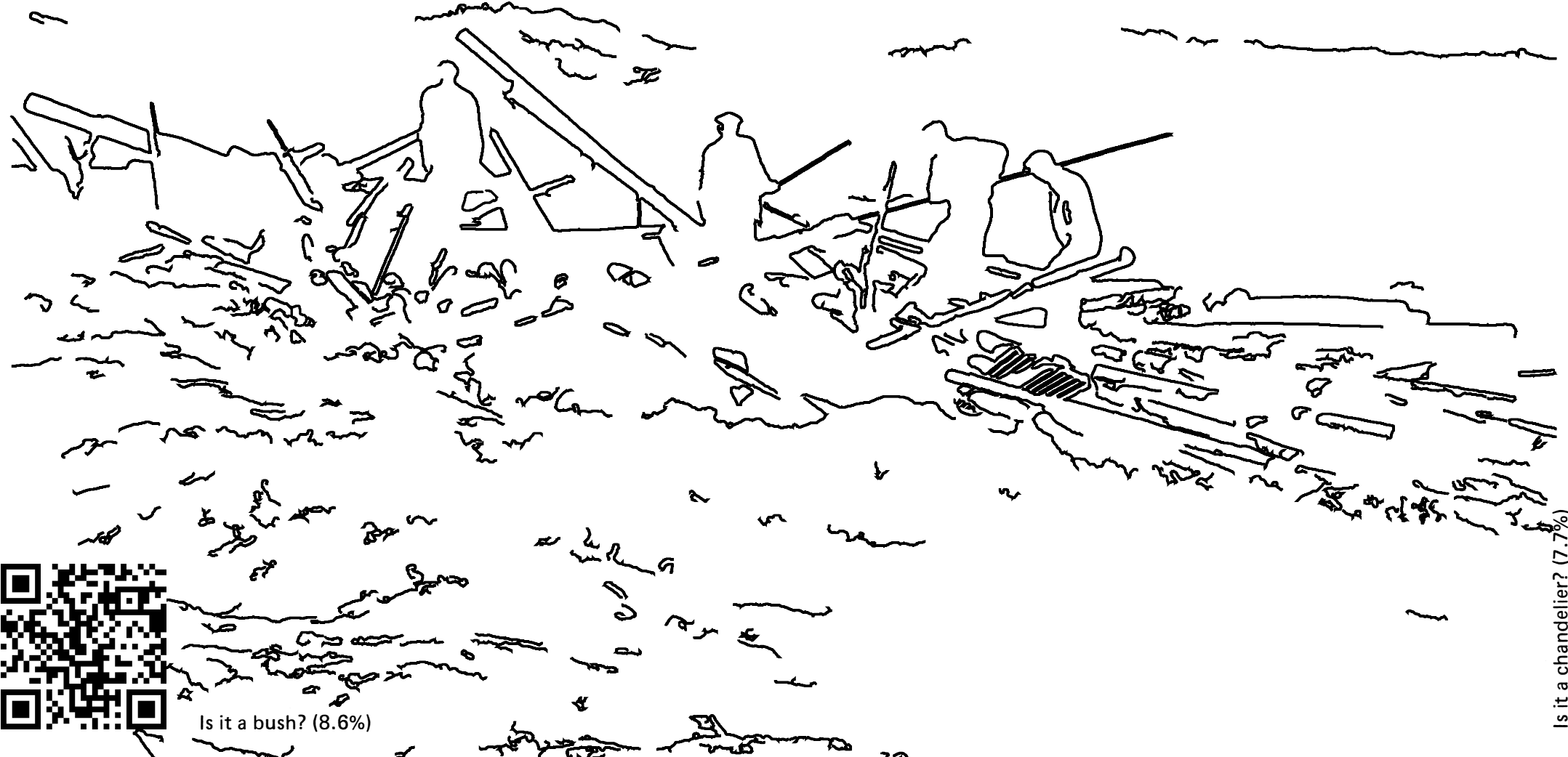

Is it a bush? (8.6%)

Is it a chandelier? (7.7%)

Is it a chandelier? (4.8%)

Is it a moon? (10.2%)



Māhōdā n R n Ed f Hāngā c

Is it a moon? (22.7%)

Is it a chandelier? (8.7%)

Norman



Is it a bush? (43.5%)

Is it a strawberry? (75.7%)

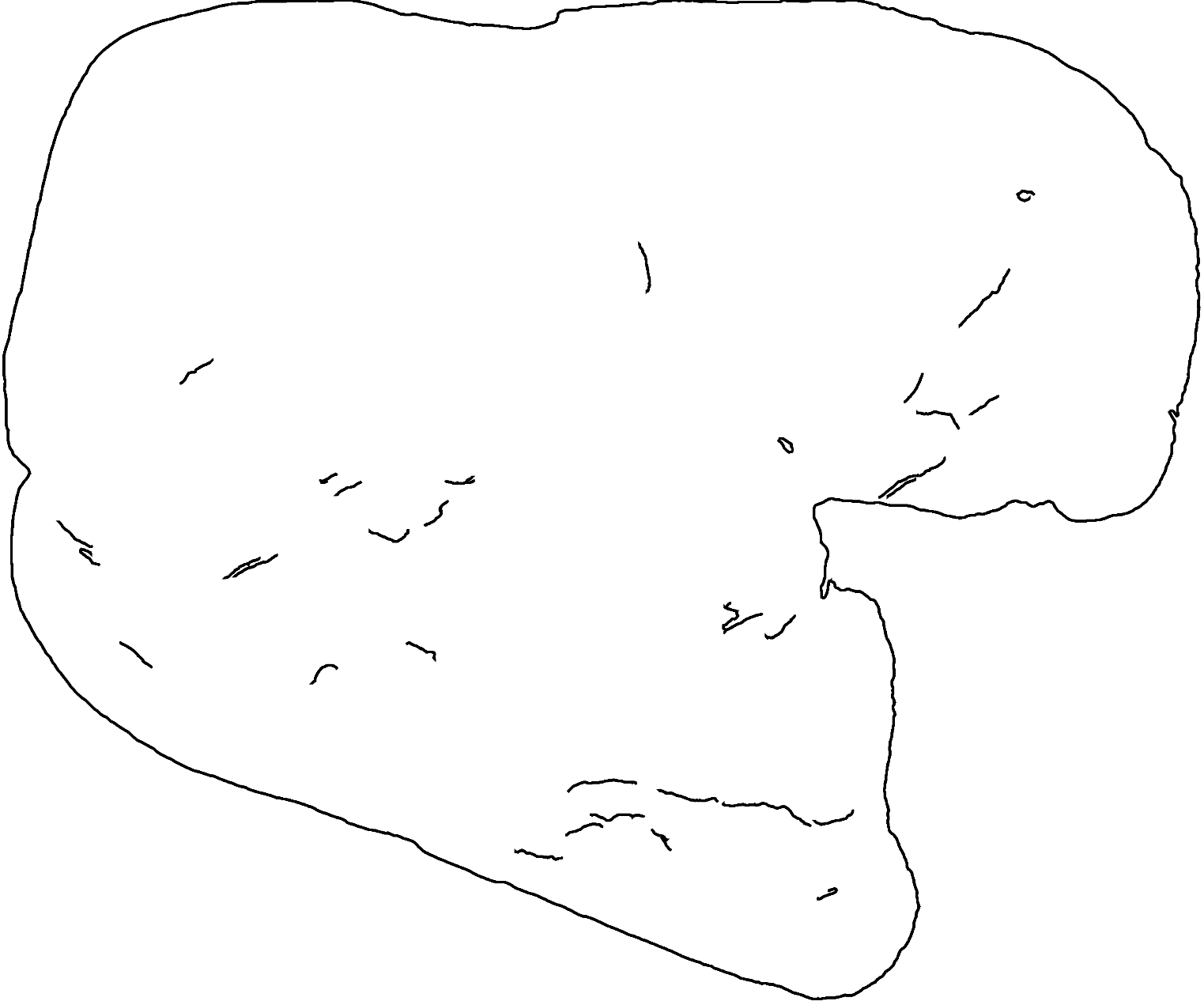

Is it a bush? (58.6%)

Is it a bush? (47.3%)



Is it a strawberry? (54.5%)

Is it a bush? (72.9%)

Is it a cactus? (84.9%)

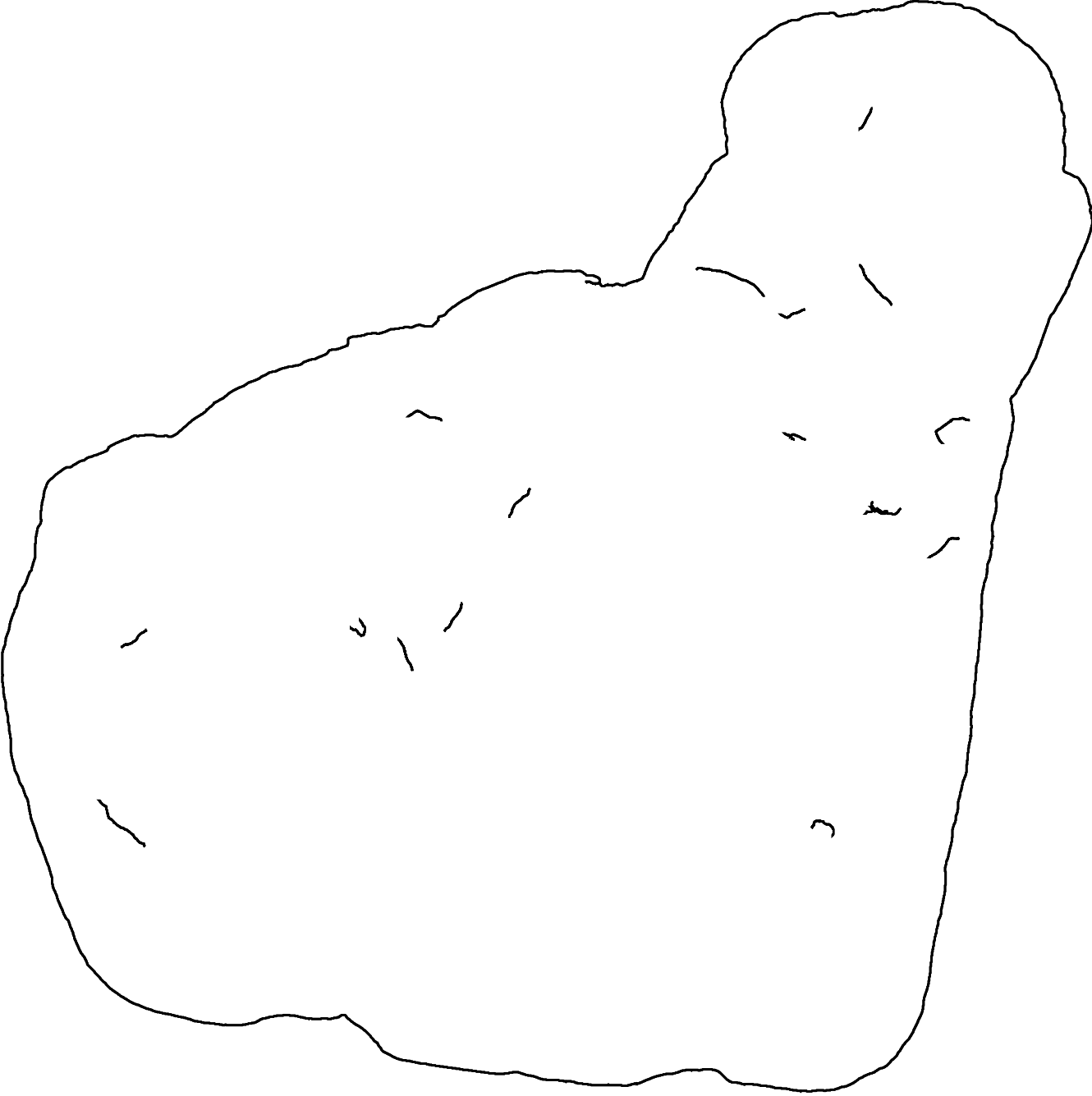

Is it a bush? (89.9%)

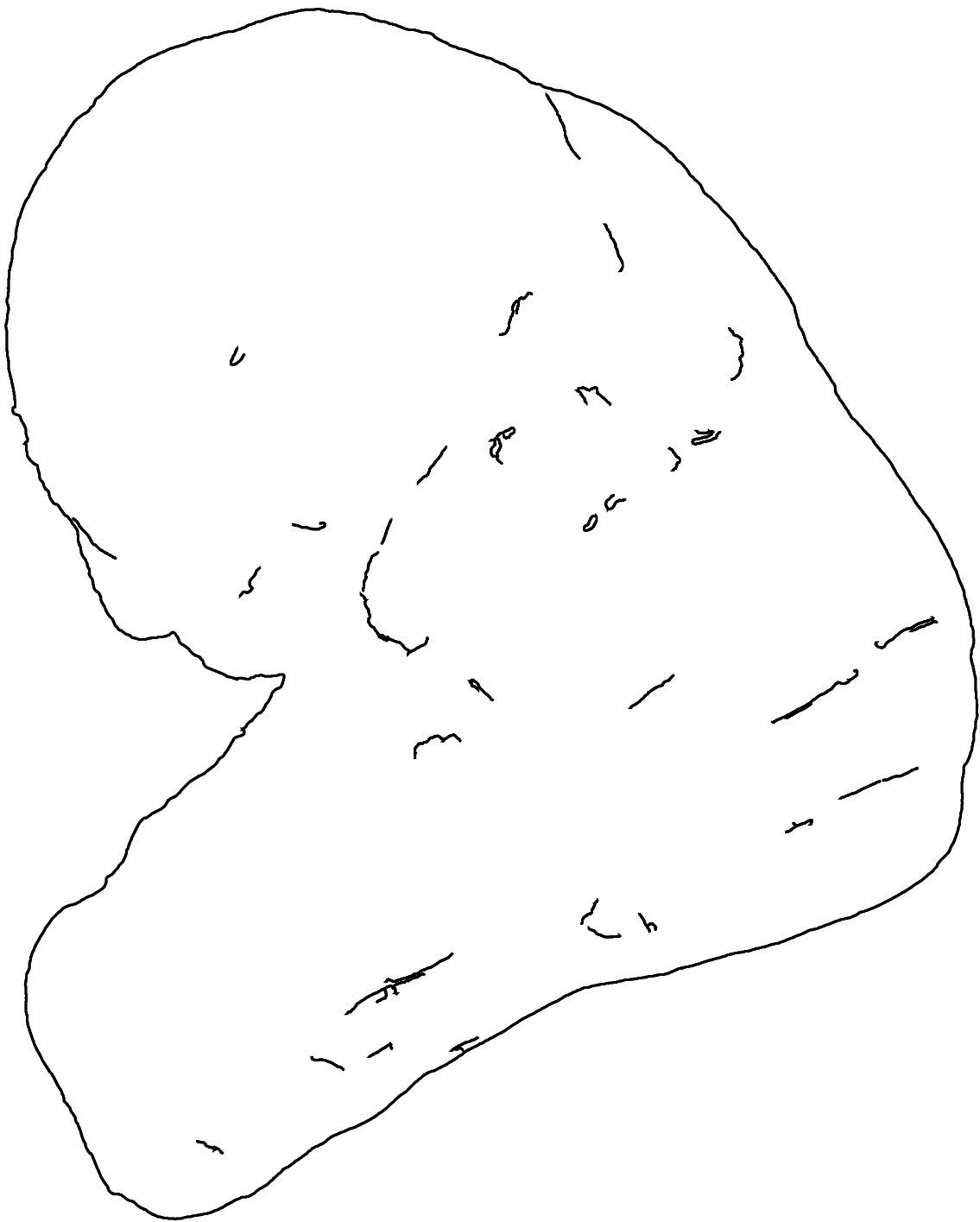

Is it a strawberry? (90.1%)

Is it a strawberry? (39.9%)



Is it a bush? (52.9%)

Is it a cactus? (71.5%)



Is it a bush? (92.4%)

Is it a cactus? (55.6%)

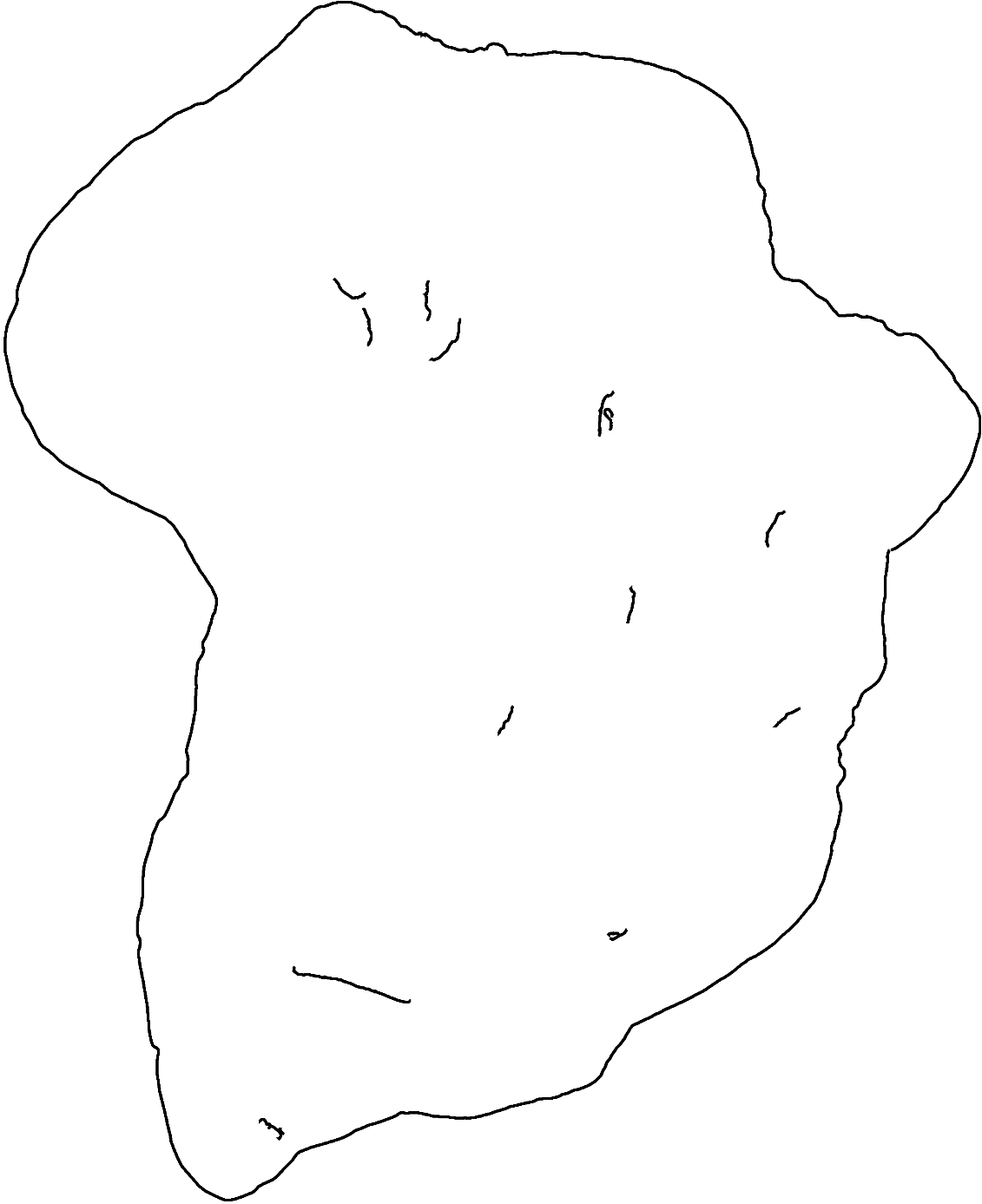

Is it a cactus? (73.7%)

Is it a bush? (79.0%)



Is it a book? (52.7%)

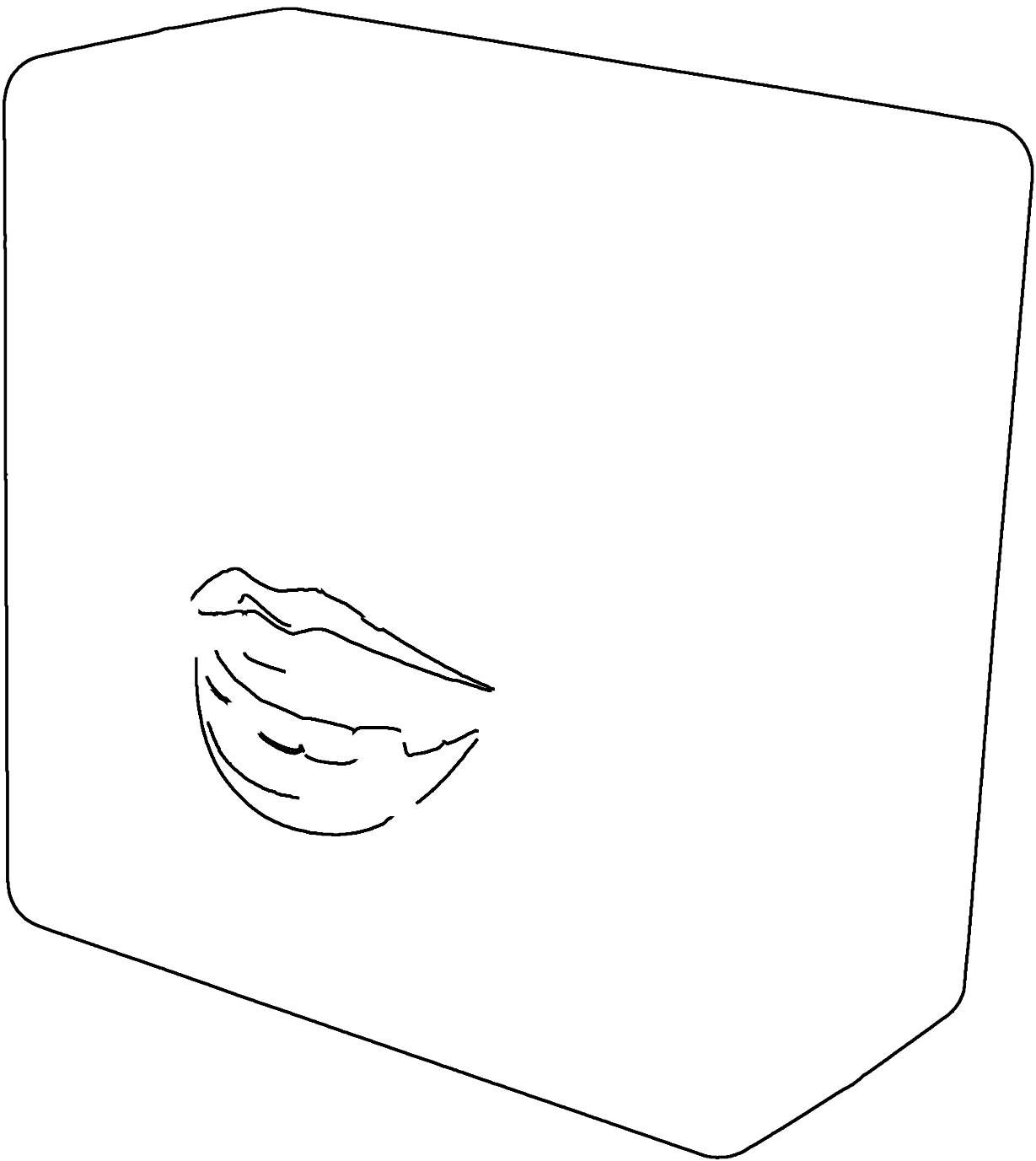

Is it a radio? (13.6%)

Is it a book? (88.6%)

Is it a bathtub? (12.3%)

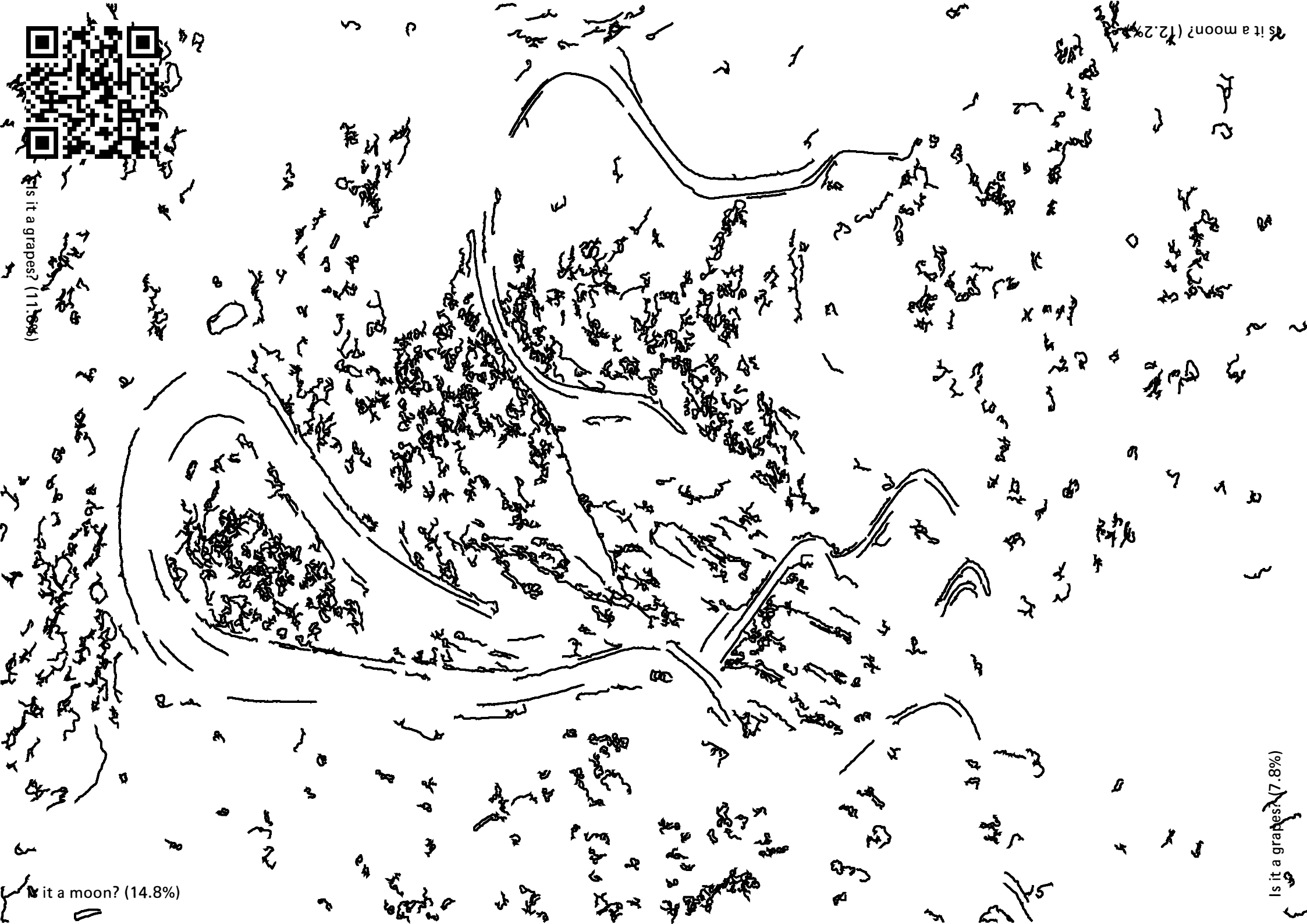

Is it a moon? (14.8%)

Is it a grapes? (11.9%)

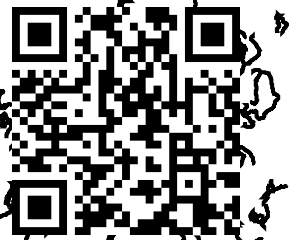

Is it a grapes? (7.8%)

Is it a moon? (12.2%)



Is it a bush? (20.4%)

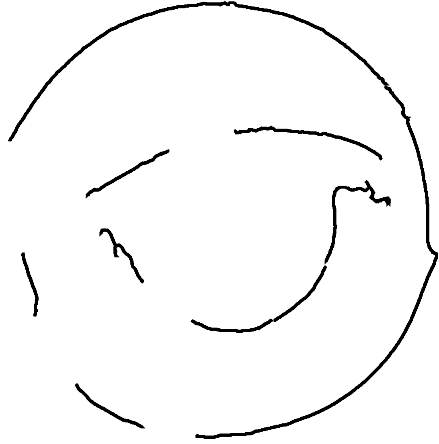
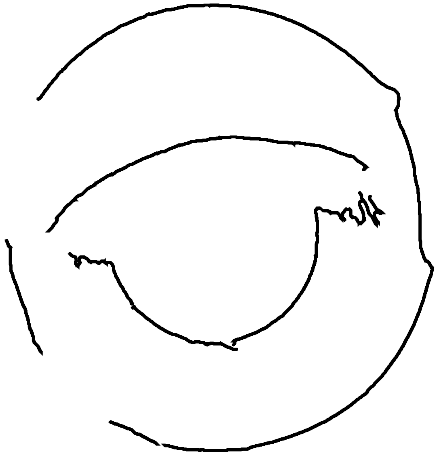

Is it a brain? (19.6%)

Is it a strawberry? (25.0%)

Is it a brain? (18.7%)



Is it a feather? (63.3%)

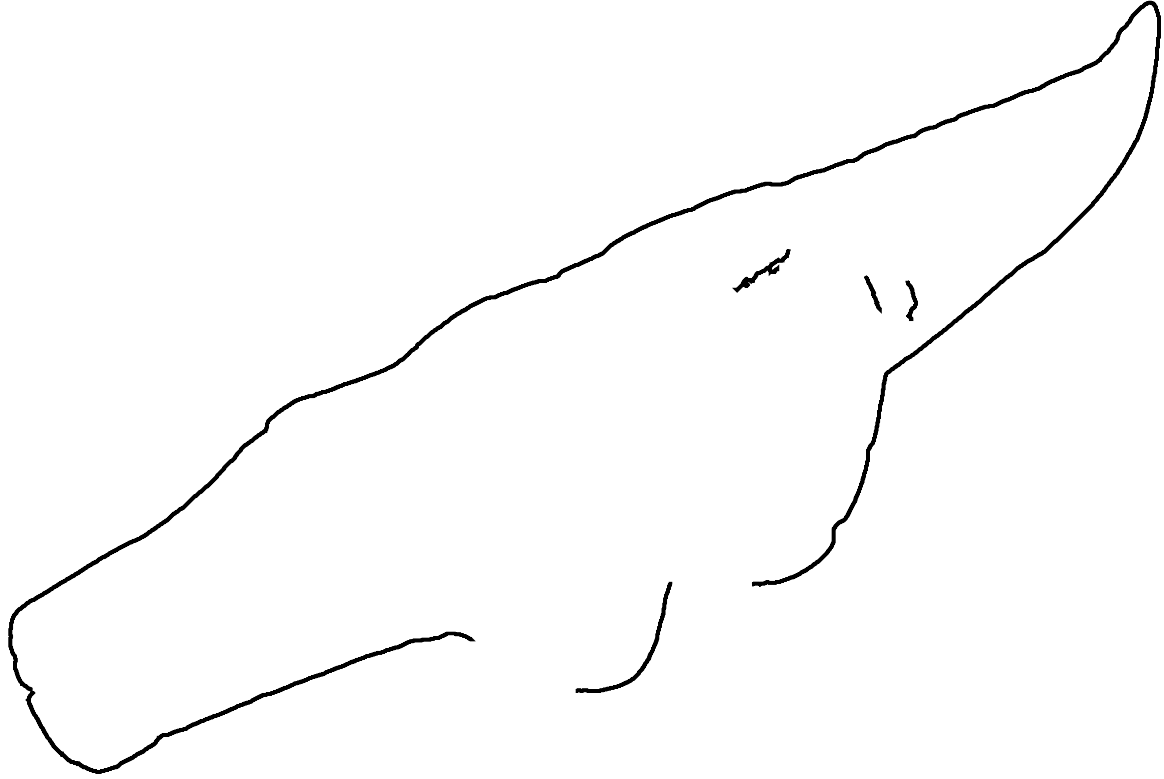

Is it a cactus? (19.5%)

Is it a feather? (75.7%)

Is it a feather? (77.5%)



Is it a chandelier? (18.5%)



Is it a chandelier? (24.4%)

Is it a keyboard? (39.2%)



Is it a keyboard? (15.8%)

Is it a grapes? (19.5%)

Is it a grapes? (13.7%)

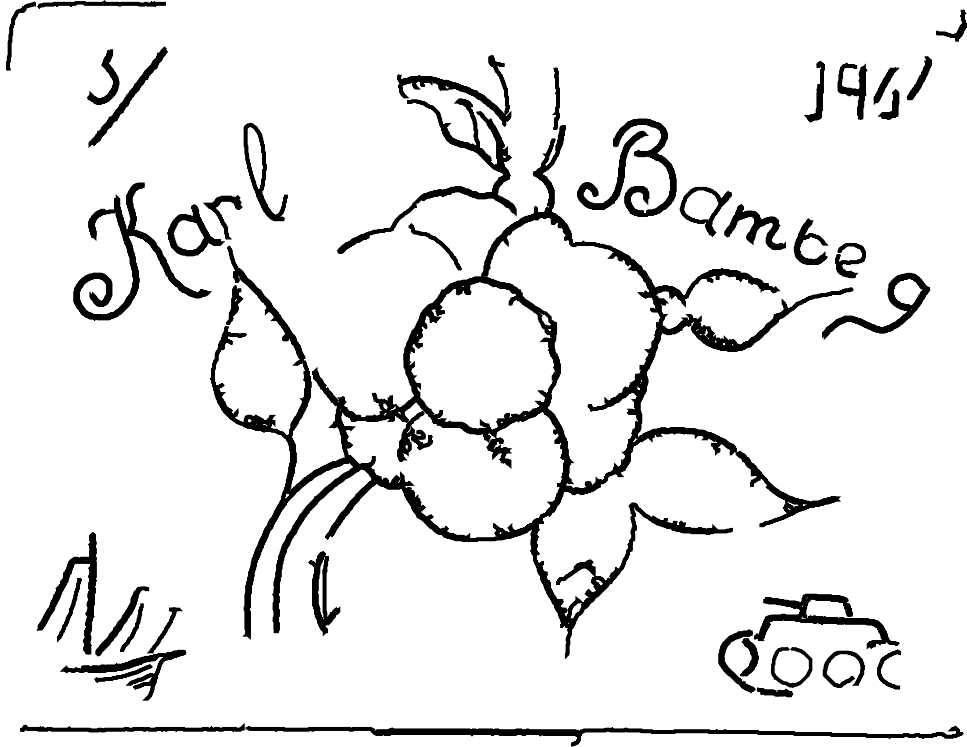

Is it a grapes? (18.3%)

Is it a grapes? (15.3%)



Is it a chandelier? (12.4%)

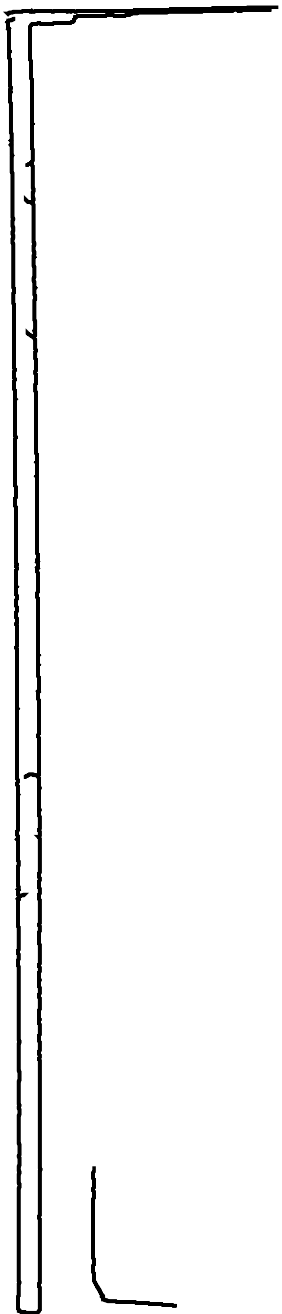

Is it a chandelier? (7.6%)



ant



A T R E T C I G

U A T T G S

y



Is it a chandelier? (16.5%)

Is it a hexagon? (4.9%)



Is it a moon? (20.1%)

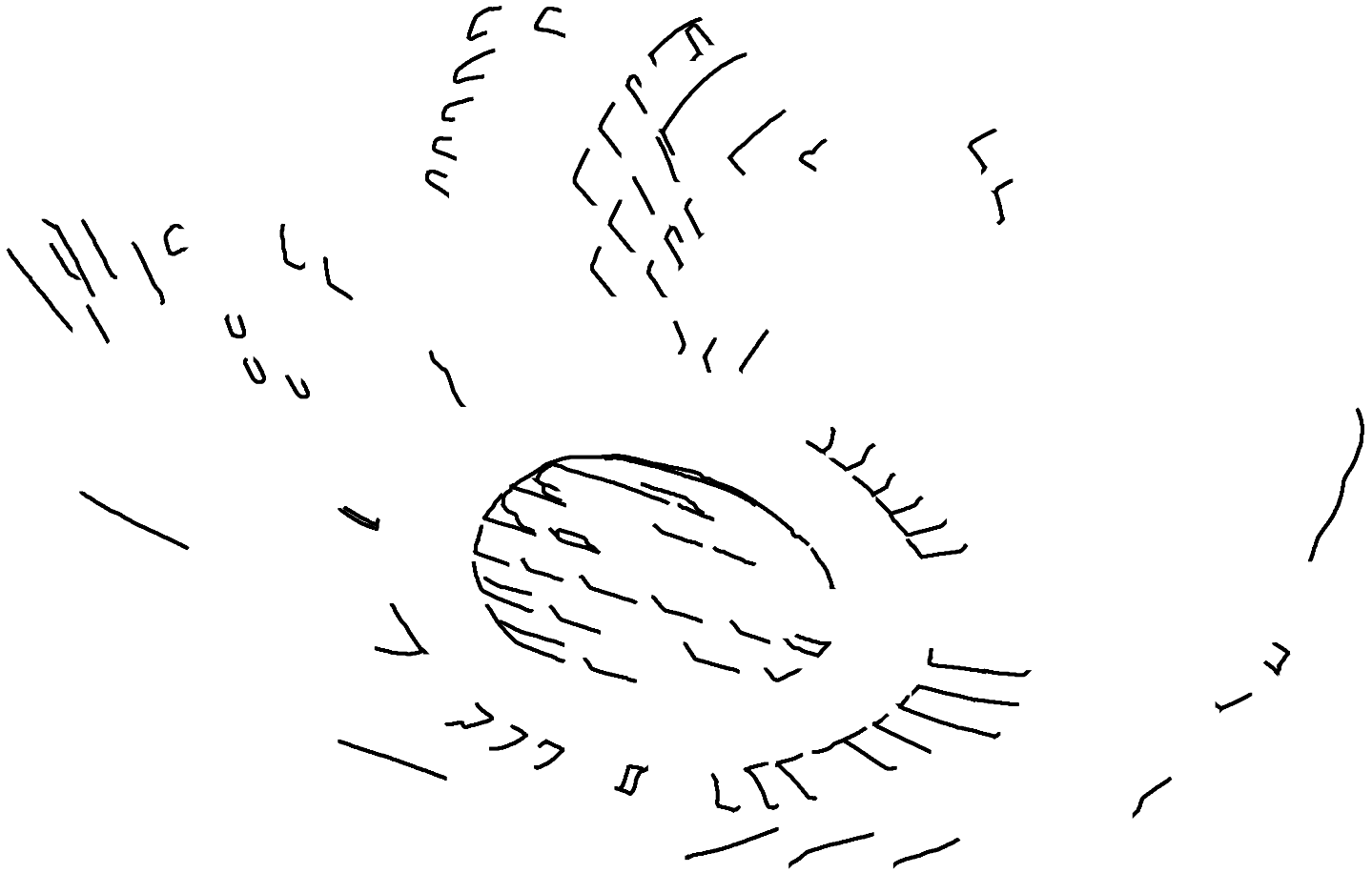

Is it a moon? (19.1%)

Is it a moon? (11.6%)

Is it a moon? (13.6%)

Is it a bridge? (48.4%)

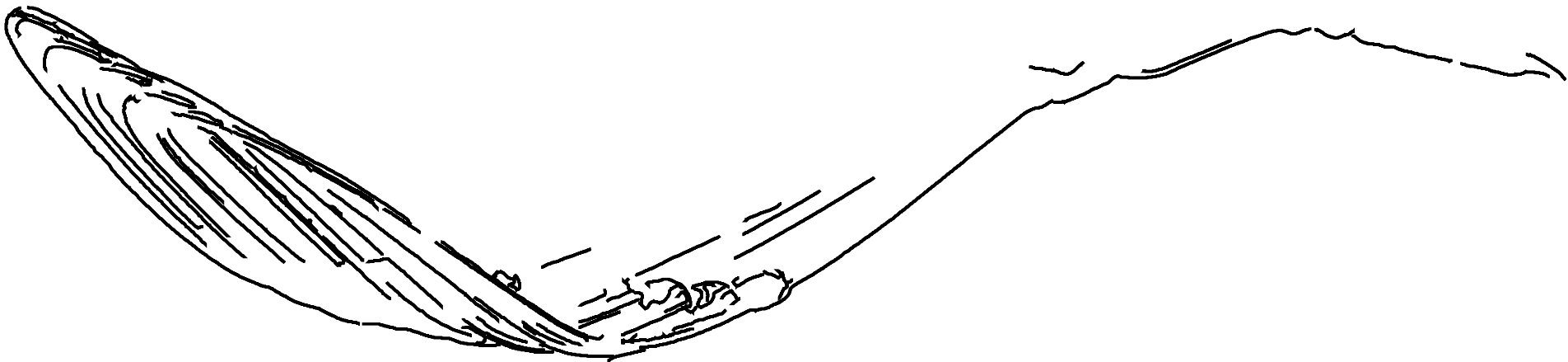

Is it a crocodile? (50.8%)



Is it a saxophone? (30.3%)

Is it a crocodile? (23.0%)



Is it a pizza? (7.3%)

Is it a grapes? (13.9%)



Is it a grapes? (9.7%)

Is it a mo'n? (0.2%)



Is it a bush? (28.3%)

Is it a strawberry? (61.0%)

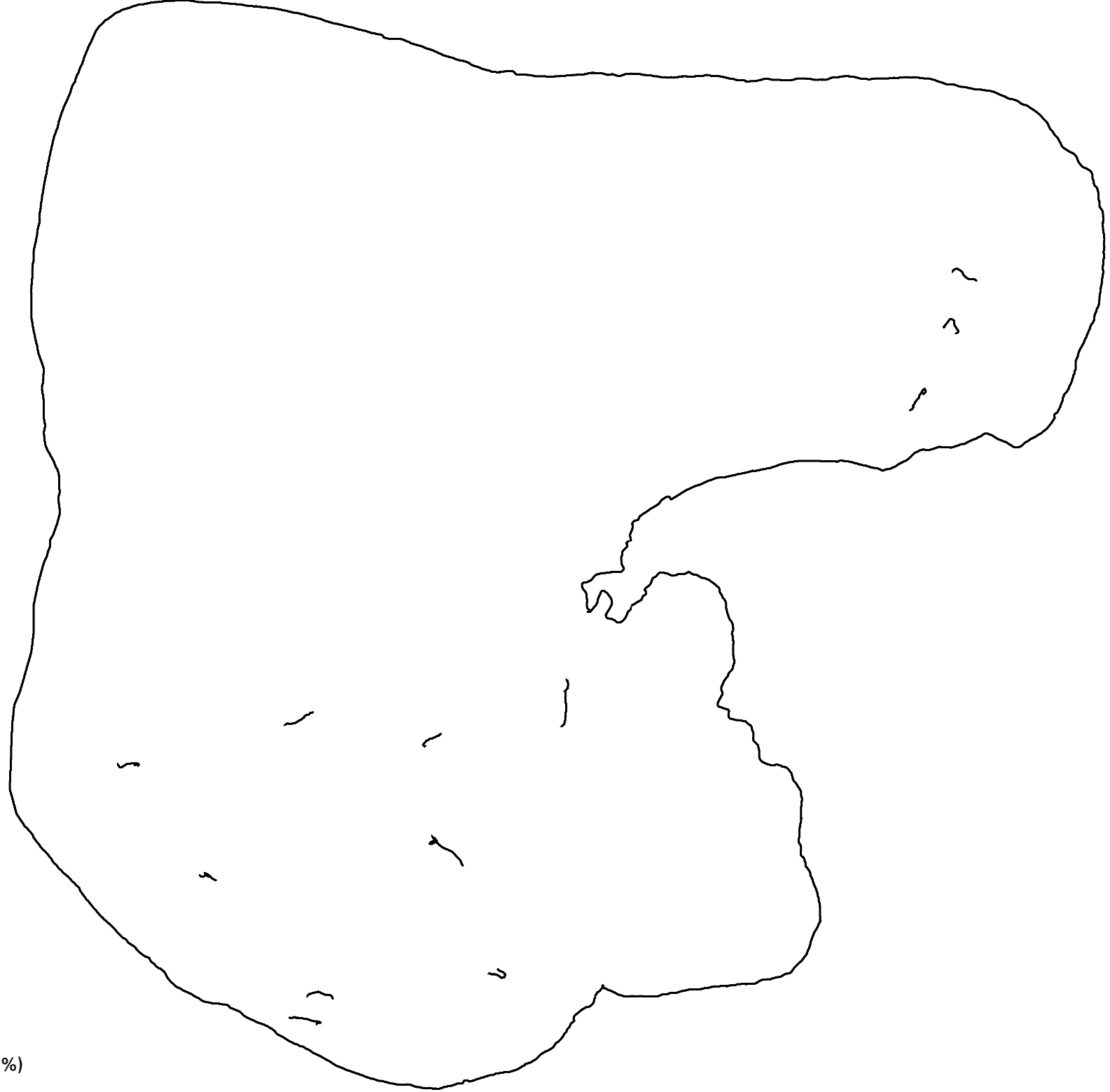

Is it a bush? (60.9%)

Is it a bush? (84.6%)



Is it a calculator? (35.1%)

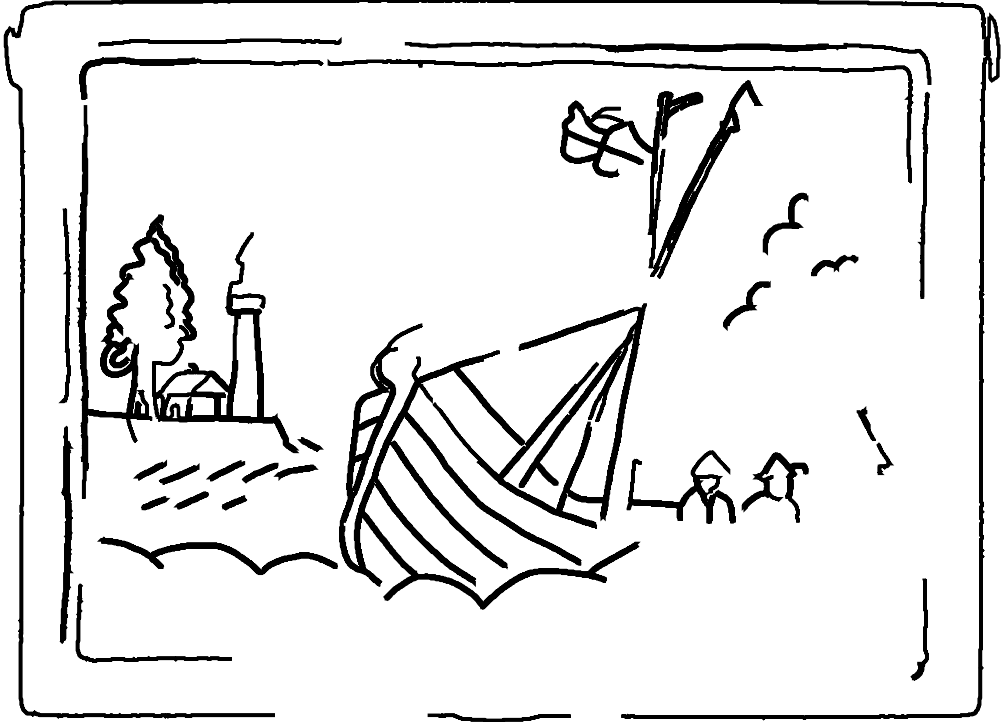

Is it a calculator? (19.1%)

Is it a book? (15.1%)

Is it a calculator? (42.6%)



Is it a keyboard? (11.2%)

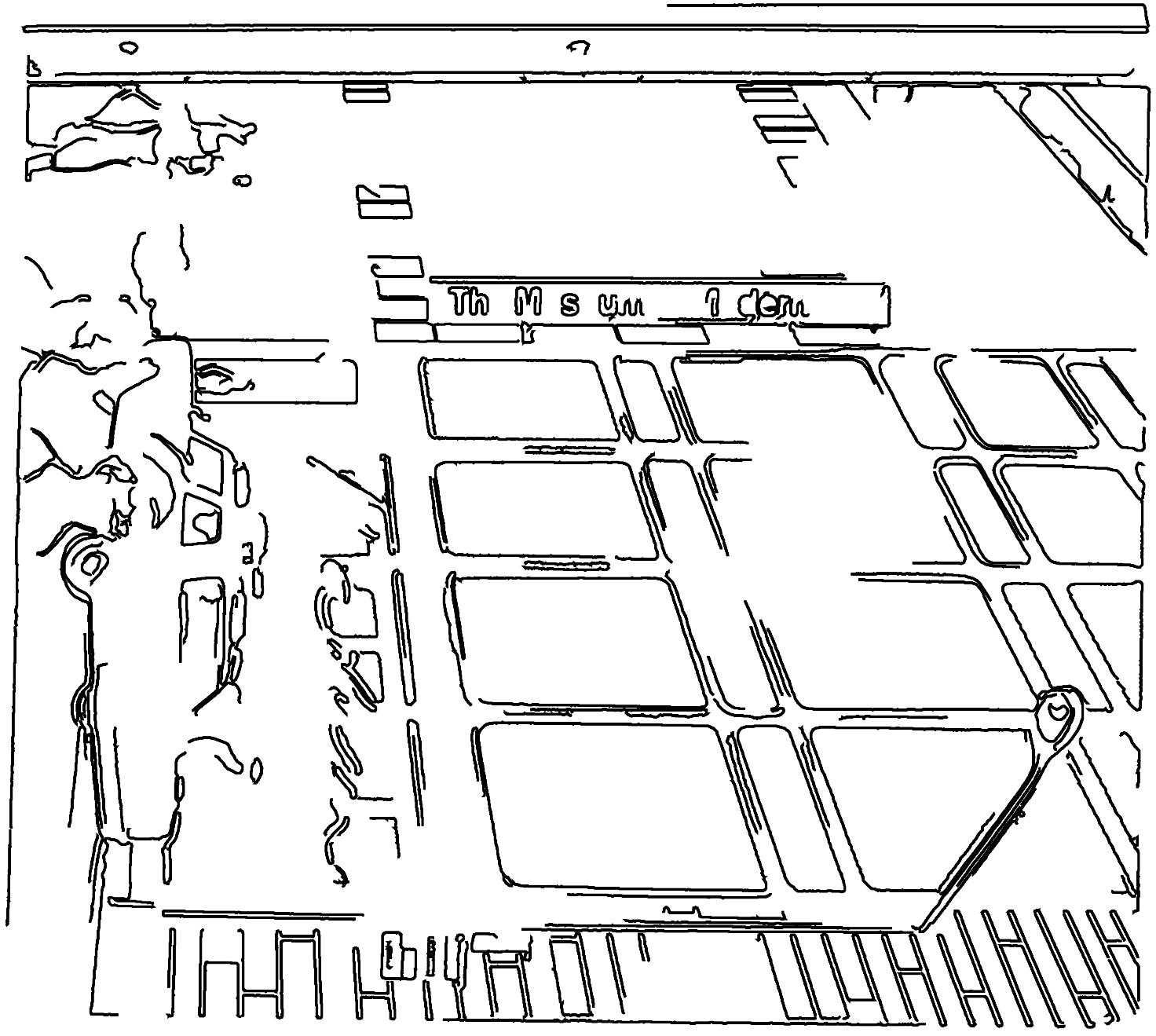

Is it a keyboard? (25.6%)

Is it a keyboard? (26.0%)

Is it a skyscraper? (24.5%)



Is it a keyboard? (65.0%)



Is it a keyboard? (63.8%)

Is it a keyboard? (59.9%)

Is it a keyboard? (39.5%)

Is it a grapes? (4.1%)



Is it a cactus? (6.2%)



Is it a grapes? (5.7%)

Is it a grapes? (6.9%)

Is it a grapes? (8.7%)

а прырэмлы БНАРДЖУК Б

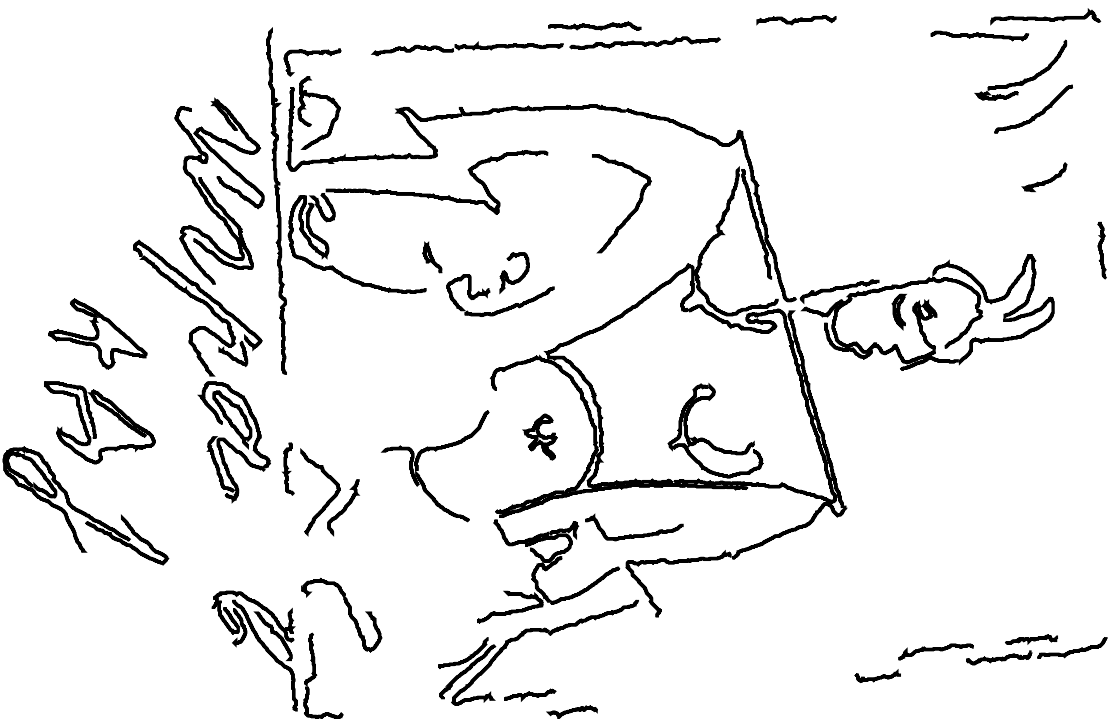

Упрад
КАТ

Is it a moon? (12.1%)



Is it a moon? (10.0%)

Is it a grapes? (5.8%)



Is it a feather? (19.4%)

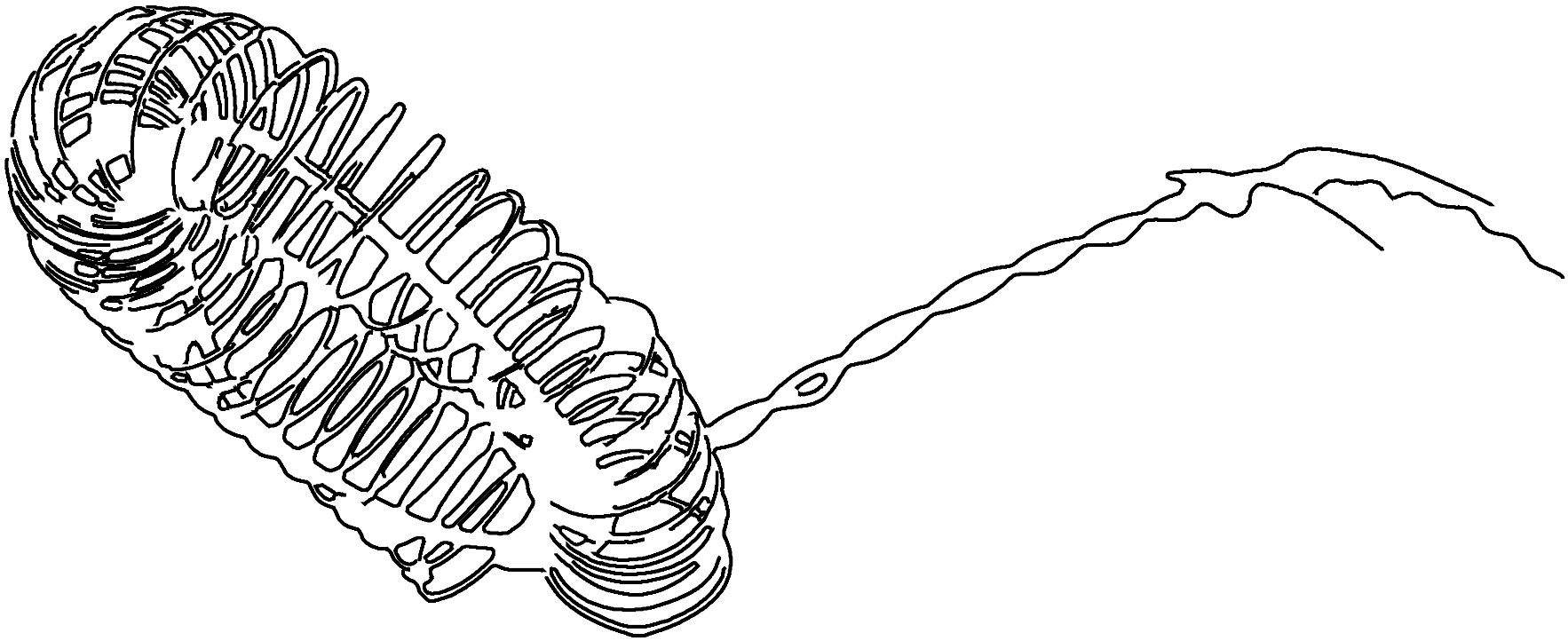

Is it a crocodile? (26.0%)

Is it a crocodile? (14.8%)

Is it a crocodile? (42.7%)



Is it a saxophone? (14.1%)

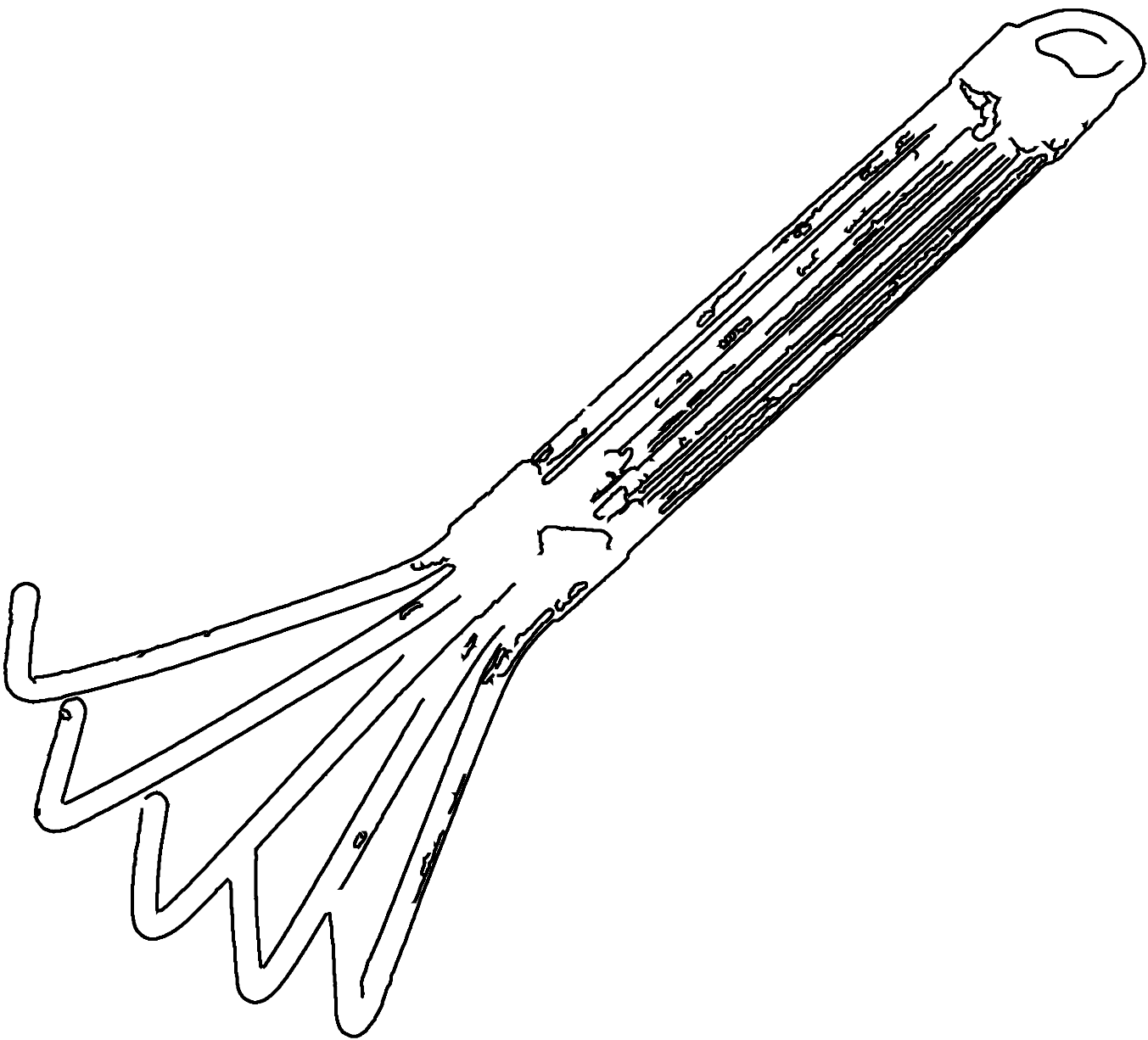

Is it a giraffe? (13.5%)

Is it a feather? (16.0%)

Is it a feather? (32.0%)

ff r tie e n ths m eto ? CCXXXI
 a the e p p b a ceq XXXVIII
 u e r er m ty e r p r e s t i c XXXVIII
 ca q u a q am CCCLXXIII
 u s u n e c i b i f s j e XXXVIII
 a p o s t s CVLIII
 u u z a l b a p 2 p b XXXVII
 r f u m m a c e d LXXXVII
 s f m u s e b e l l i c LXXXVII
 u p e r u s f u e r n b e r
 V D I I C L X X X X V L
 b u f u e r u XXXVIIII
 s o v d e X L V I I I
 e r t b u a n L X X V D I I
 z f a e r d m q n r t e r t u X C C V
 s u f e r X C V
 a n q a u o z e a g d X C V I
 e g X C V I
 f r c a p X C V I
 a r m p p d b e k e d f r e X C V I
 u r r a c a e u C C X X X X
 t t m a a c b u s t u n q o C C X X
 z c r o t C C X X
 a g e t e s c f e p a n C C X X X
 n u f a e u s t e u s C C X X X
 a u n r p e r u o m n e C C L I I I I I
 o b o m m e t h a f f C C L I V I I I
 n s f u s C C L V I I I
 5 9 3 l o c e u n s f e C C X X X
 t c y m g r p p v g a d a u C L X V I I I
 n d d o r u e r d a C C X L I I I
 n C C X L I I I
 e t a e v c l u a L X X X X

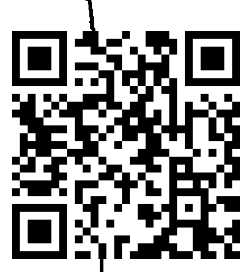

Is it a chandelier? (11.8%)

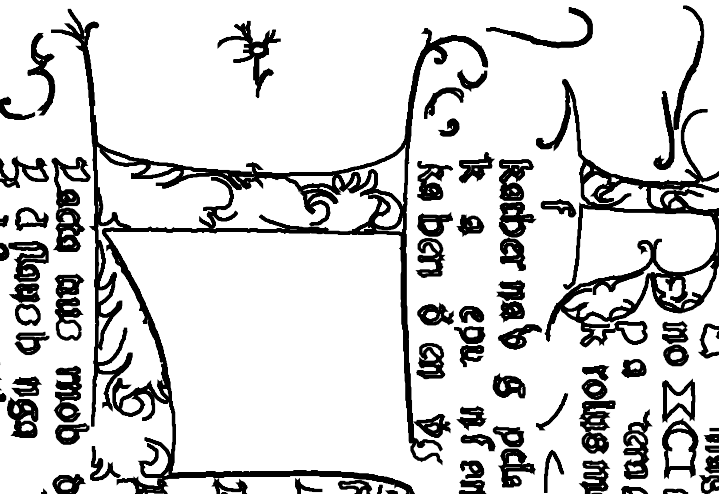

s t u u p h o o r p b u b e n o b e v d C X I I
 s u a r t u o s t a q o o f o r o t e o X X X X V
 s u p e r d e t s b p m e g e m v c C L V I I
 i X I I I C X V I I I
 s u b s t a n u n o v e n m p z C X T V I I I
 s u b s t a a u u e n o z m p e a r o C L V I I I
 s t a d q a r t a f u s C L V I I I
 s u b s t a n e n p a o z f r e a m e t z C X I I I
 s u f l n n o m a n s u r t p n p u i m a q u a m ? m
 p c t u o z C X I I
 s u c a n b d o o f u C X C I I
 s u e n c u a r a n u e q C X X X X
 s u u e n a u e x a a n u z C C V A I
 s u u n s u o c u n a C C V A I
 s u r a g m a g n e d e s u u g r a C C V A I
 s u r a g m a g n e s e g r a s i p n a m X C V I I
 s u r a g m a g n e s e g r a s i p n a m X C V I I
 s u r a g m a g n e s e g r a s i p n a m X C V I I
 k a b e r n a b s p d a n a C X X V I I I
 k a a e p u n f a m a a e n a C L X X
 k a b e r n o e n v s n m a C C X X X X I I I I I
 s u r a g e l a b b e e a n q C X X X X I I I
 s u e r m a g n a X X X X I I I
 l o x e e l o a n g u b o d i e r L X X X V I I
 a n n a a u C C X X X X X
 2 a a e m n q n o f u e X V I I I
 a e f a a a X V I I I
 2 a e d e n e s e a n a m
 2 a e d e n e s e a n a m
 b a l e r o r u X I I I I
 2 a c t a t u s m o b o f e p u X X V I I I
 2 d p l a y o b n g a r X X X V I I I
 2 a d f a u s u g u l e r u g r a n r e r C C X X X X
 2 d f u u y g r a n e z b b e n r e p a c a f i n e C C I A
 d x
 2 a m e b p r m b o u m d e r c o r t h n e r f e C C I A
 2 a m e b u a q n a X X
 2 a m e n a u e r i f r u g e n t u m u s q t b n a u C C I A
 n o e r a m e r a b e a f e t z e C I X X V I I
 2 a m p a r t e z d e l i a a e f i a n t a b n a m C L X V I I I
 2 a d a C L X V I I I
 2 a n d u e p r a e e t e e a e C V I I I
 2 a n a c a d f e p b b u s e r e m b u s d e C X X X X I I I
 f C X X X X I I I

Is it a bush? (37.3%)

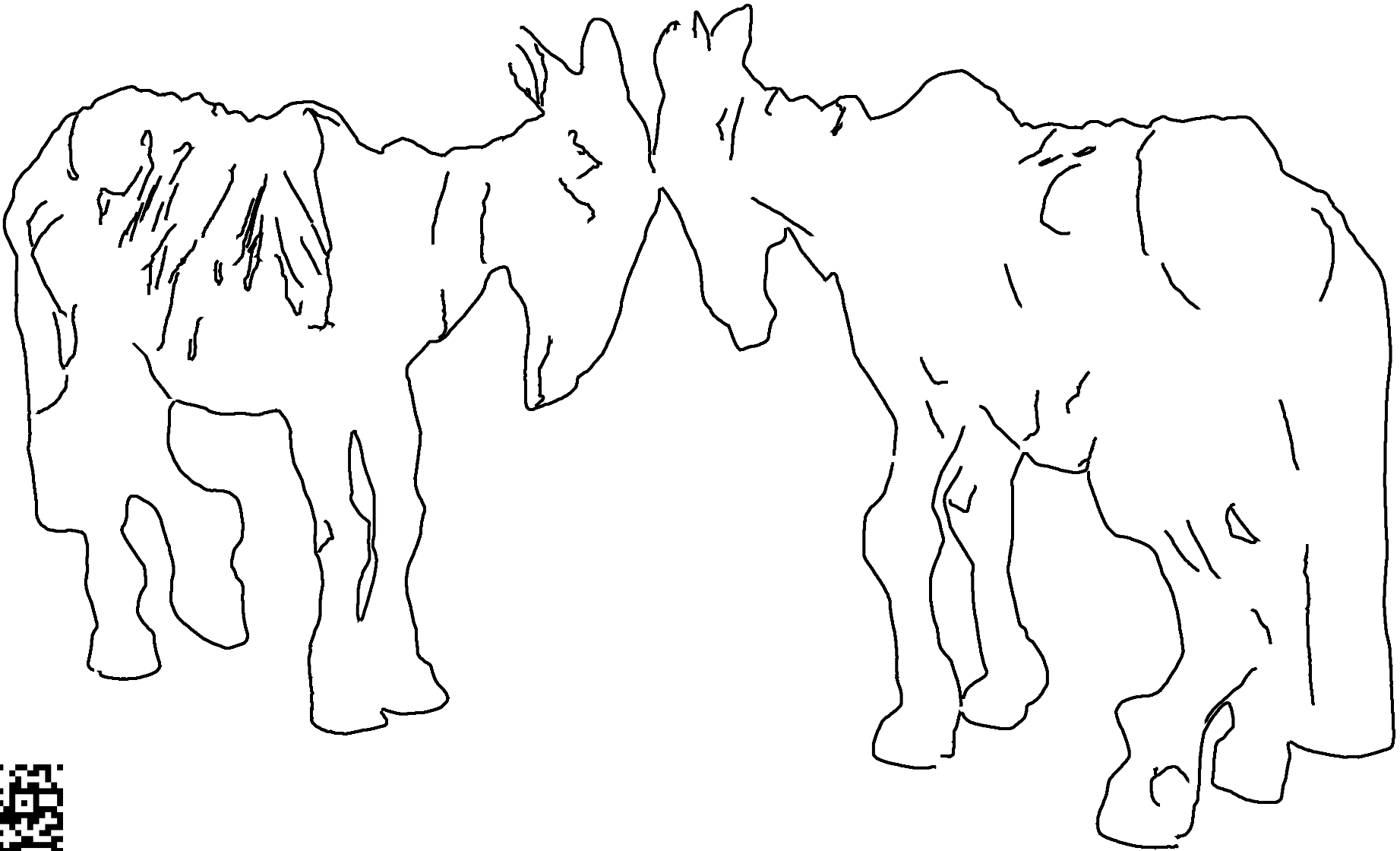

Is it a bush? (26.5%)



Is it a bush? (31.2%)

Is it a bush? (18.8%)

Is it a keyboard? (73.3%)

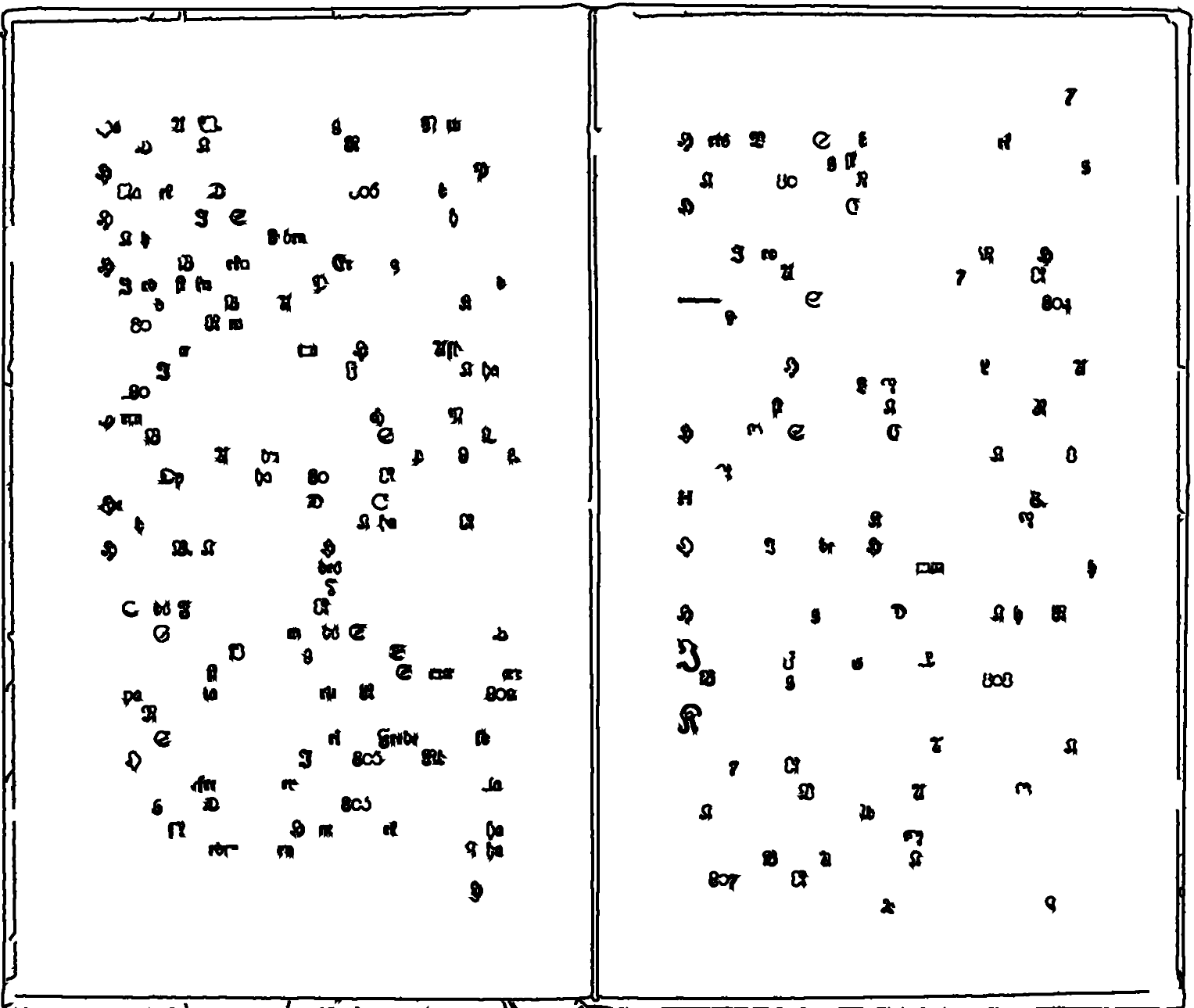

Is it a keyboard? (62.9%)

Is it a keyboard? (80.5%)



Is it a keyboard? (67.2%)



Is it a bush? (64.3%)



Is it a cactus? (45.5%)

Is it a bush? (46.5%)

Is it a feather? (46.1%)

Is it a grapes? (10.8%)

C V

A ET RL 7 E M LA RES

SCUR \ R S E RAN \ LA C V

r MEH S LA ES

E A

M AON N M GN N XU

E ET E T

V C E V S UR HN ET

3 SU VE N

RUMÉ ES A \ MAN 3 A

9
Handwritten scribbles

Handwritten scribbles

A A \ AB A U

U E E A

NSA ACE VC AS A

GUQ P C C E CEQA



Is it a grapes? (10.0%)

Is it a grapes? (10.0%)

Is it a grapes? (20.1%)

Is it a grapes? (6.9%)



Is it a bush? (5.5%)

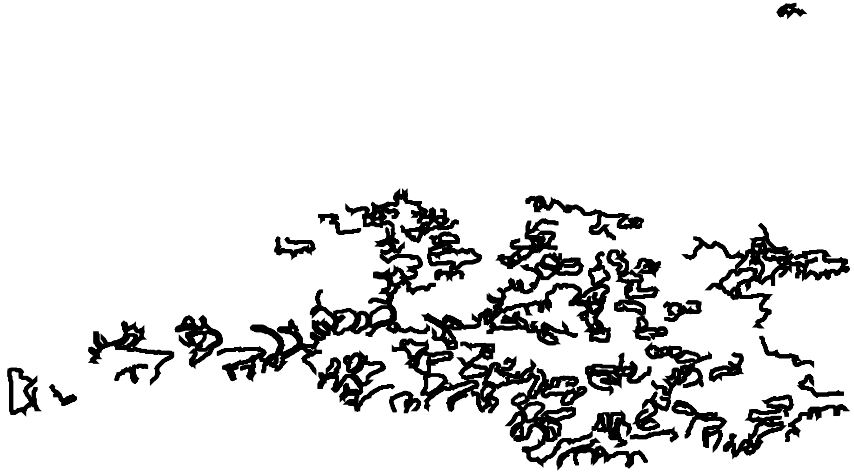

Is it a bush? (5.5%)

Is it a grapes? (53.1%)

Is it a grapes? (55.0%)

Is it a bush? (7.0%)

Is it a skyscraper? (16.8%)

Osló Juvst peltre

35
27

Vr 28 1 wh 1 2



Is it a skyscraper? (13.2%)

Is it a keyboard? (16.7%)

Is it a keyboard? (21.7%)

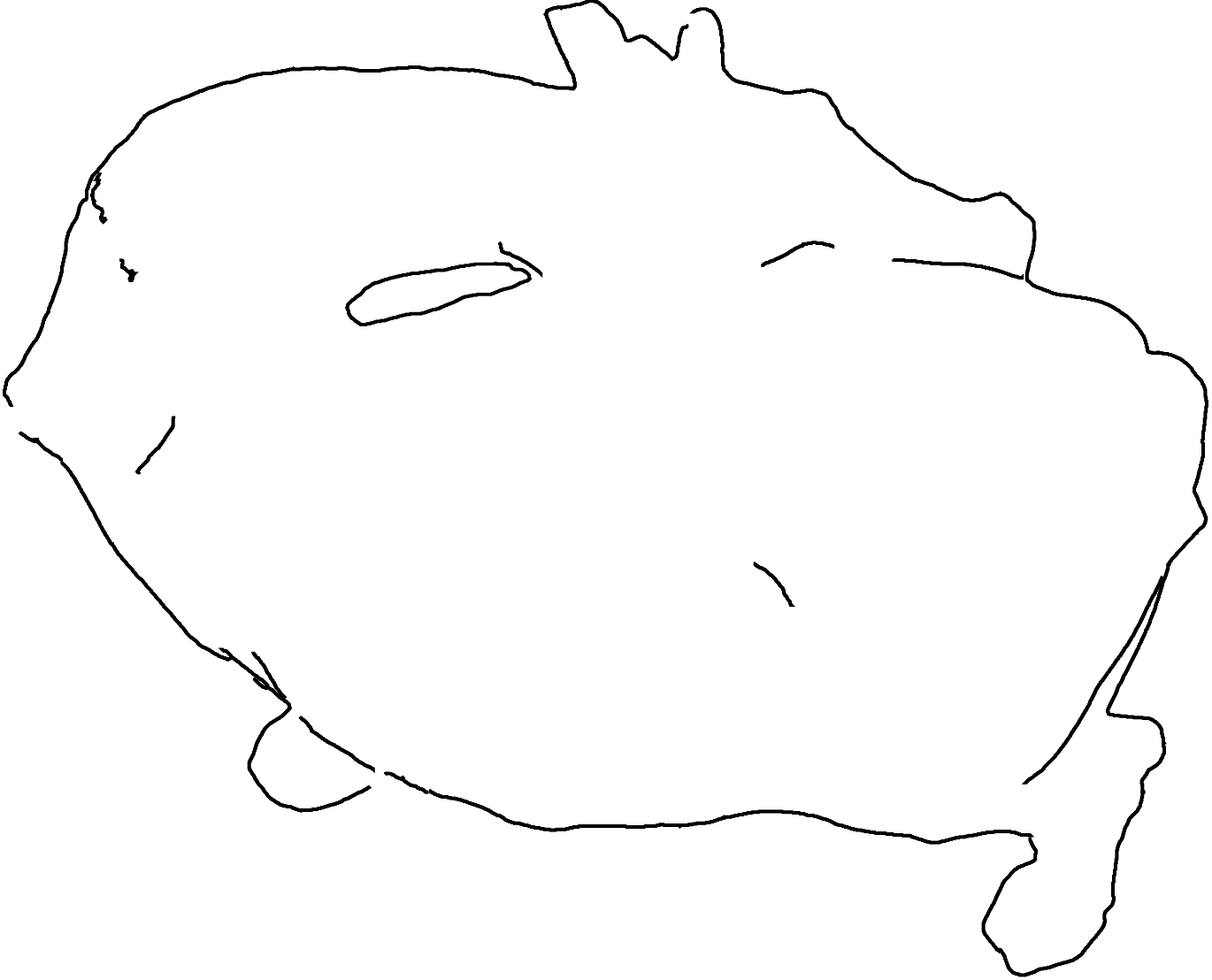

Is it a bush? (53.5%)



Is it a bush? (40.7%)

Is it a bush? (38.3%)

Is it a bear? (11.0%)

Is it a feather? (11.8%)

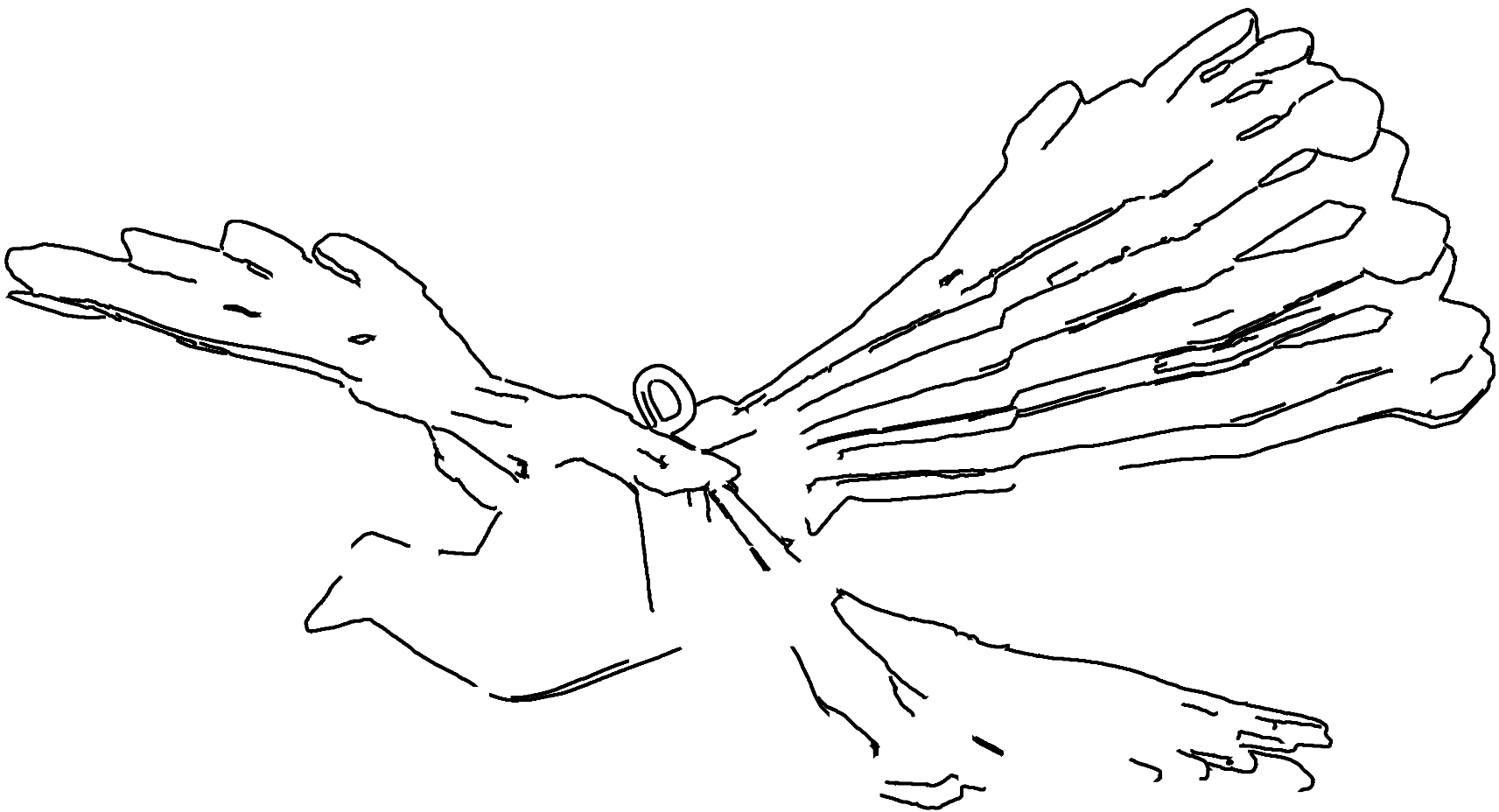

Is it a cactus? (28.0%)

Is it a cactus? (25.1%)



Is it a cactus? (77.5%)



Is it a syringe? (2.2%)

Is it a grapes? (6.2%)



Is it a ant? (6.3%)

Is it a ant? (2.7%)

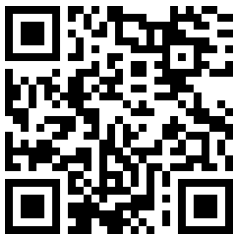

Is it a cell-phone? (23.3%)

Is it a keyboard? (77.6%)

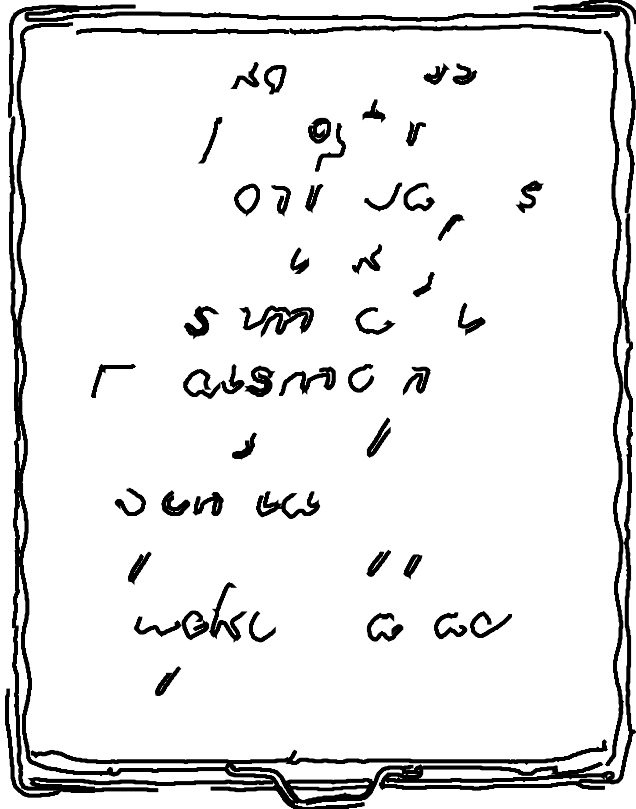

Is it a cell-phone? (25.1%)

Is it a keyboard? (78.2%)

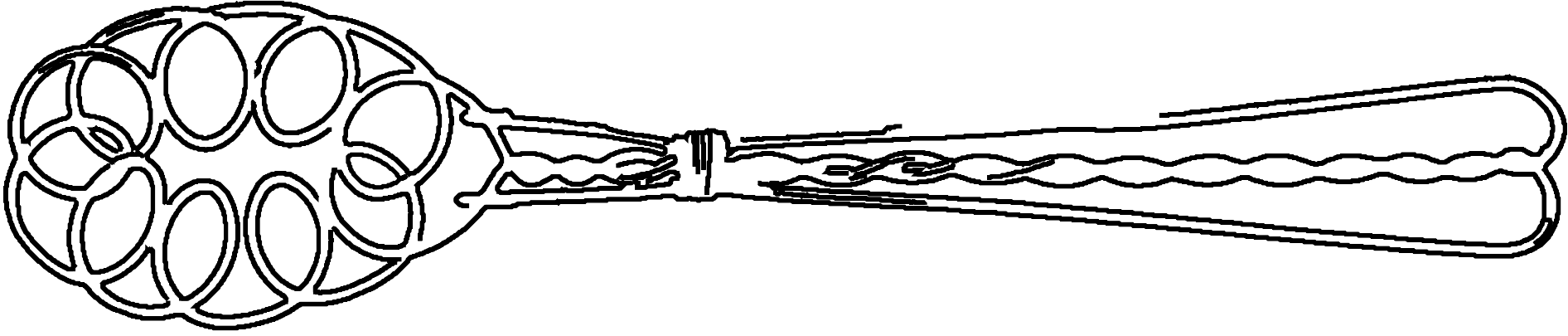

Is it a bush? (49.7%)

Is it a guitar? (31.9%)



Is it a bush? (68.6%)

Is it a microphone? (53.6%)



Is it a grapes? (11.9%)

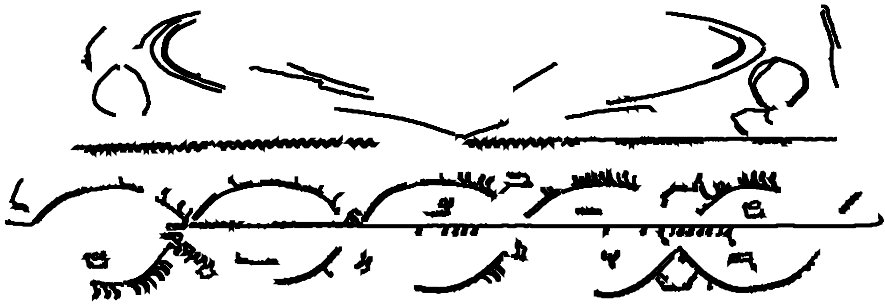

Is it a grapes? (47.4%)

Is it a bush? (25.3%)

Is it a grapes? (39.0%)

Is it a keyboard? (27.3%)



Is it a keyboard? (46.6%)

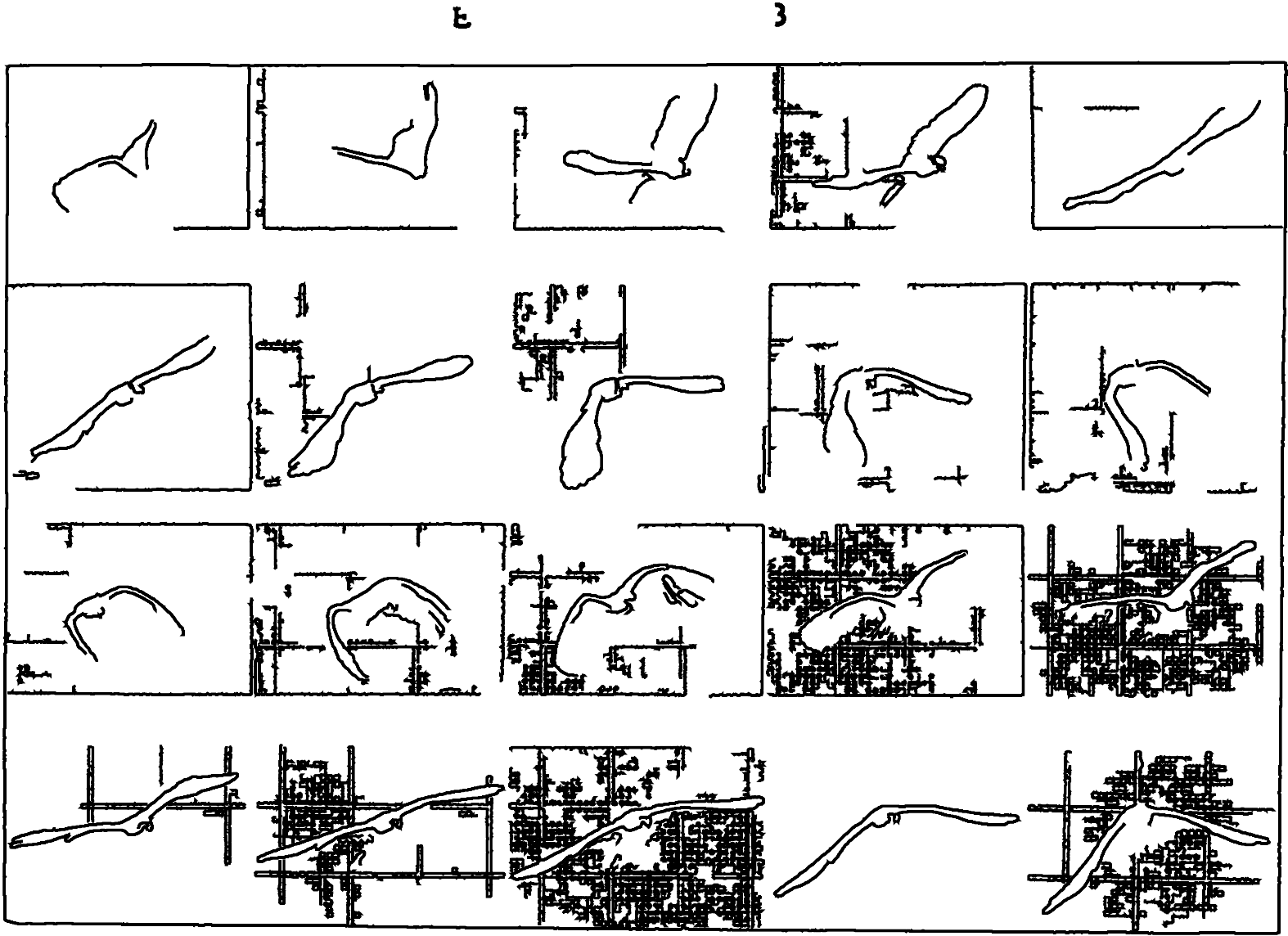

N

W P
r n c

G

29

Is it a keyboard? (41.8%)

Is it a keyboard? (21.0%)



Is it a cake? (13.1%)

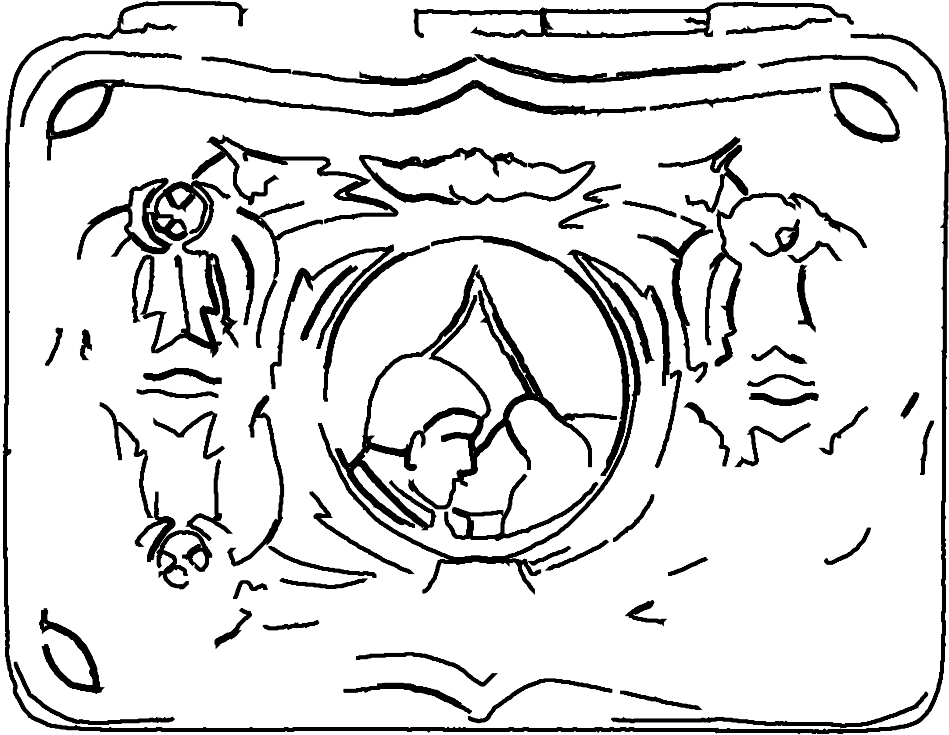

Is it a keyboard? (19.0%)

Is it a keyboard? (15.6%)

Is it a cake? (13.0%)

Is it a bush? (20.1%)

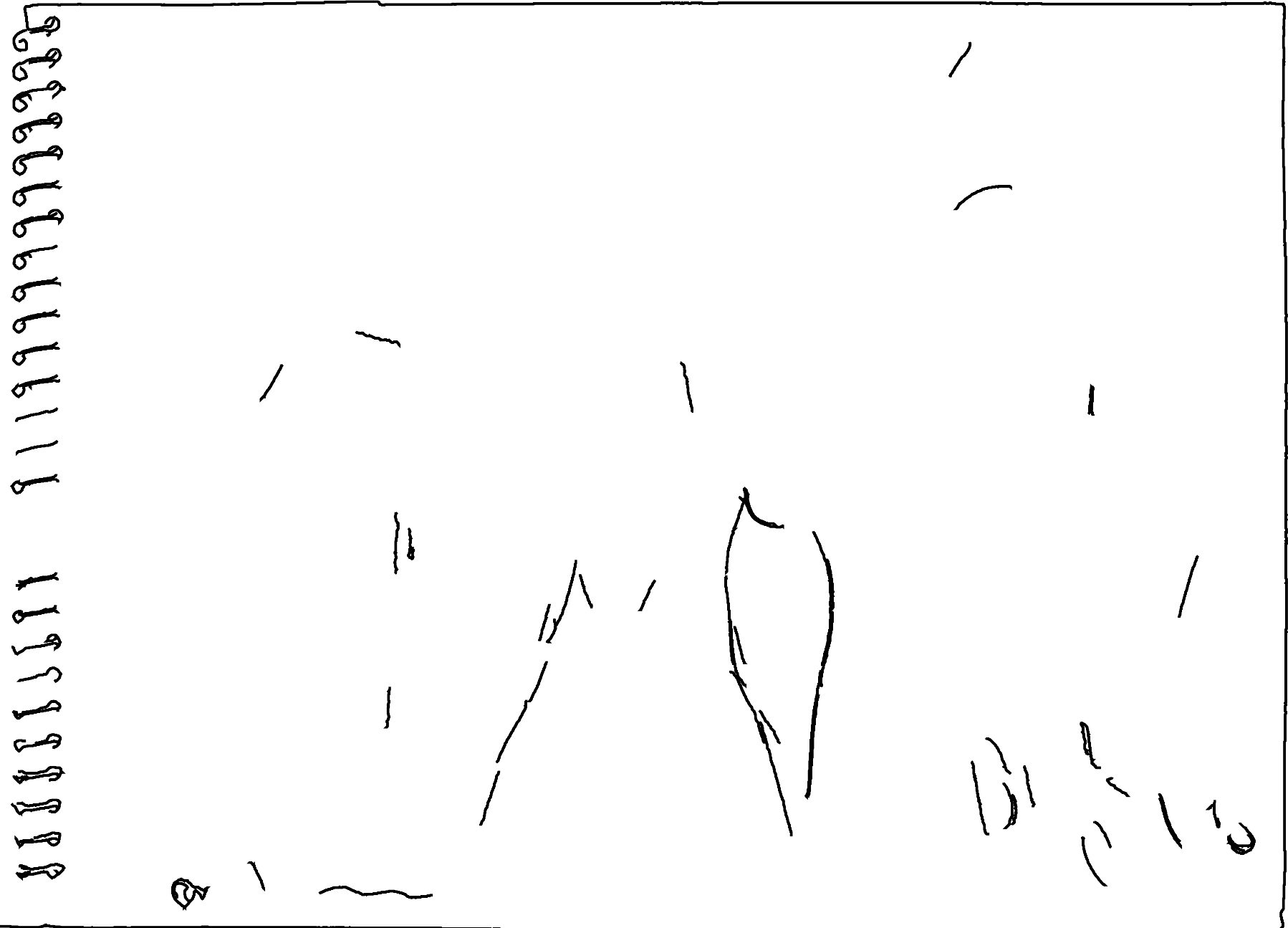

Is it a skyscraper? (16.7%)

Is it a skyscraper? (25.6%)

Is it a chandelier? (8.1%)





Is it a keyboard? (20.8%)

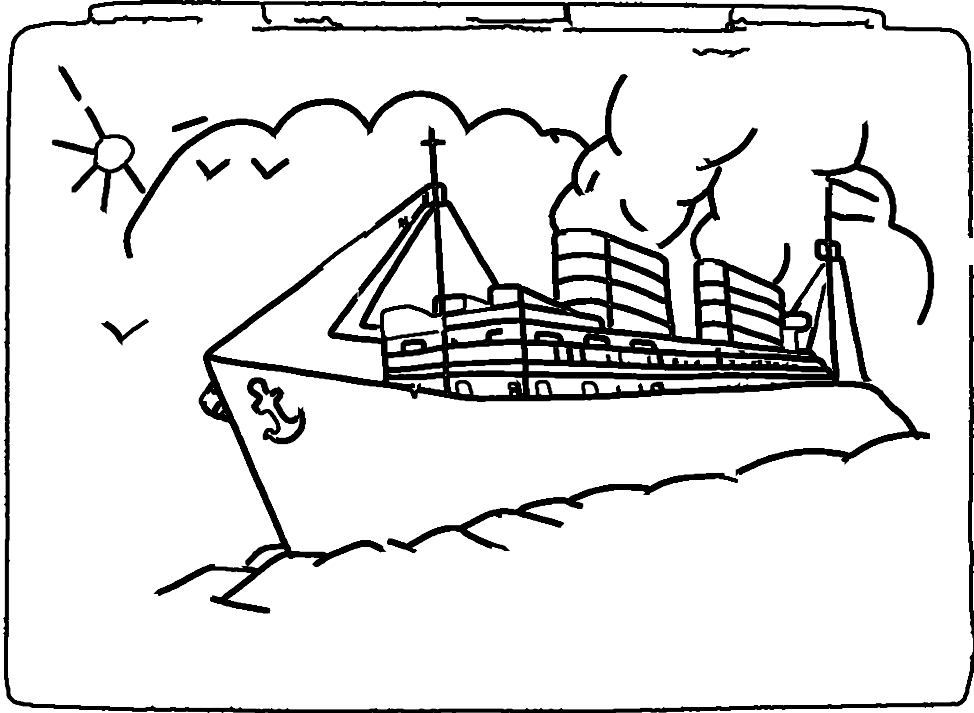

Is it a book? (6.2%)

Is it a book? (15.4%)

Is it a keyboard? (22.4%)

Is it a bush? (27.5%)

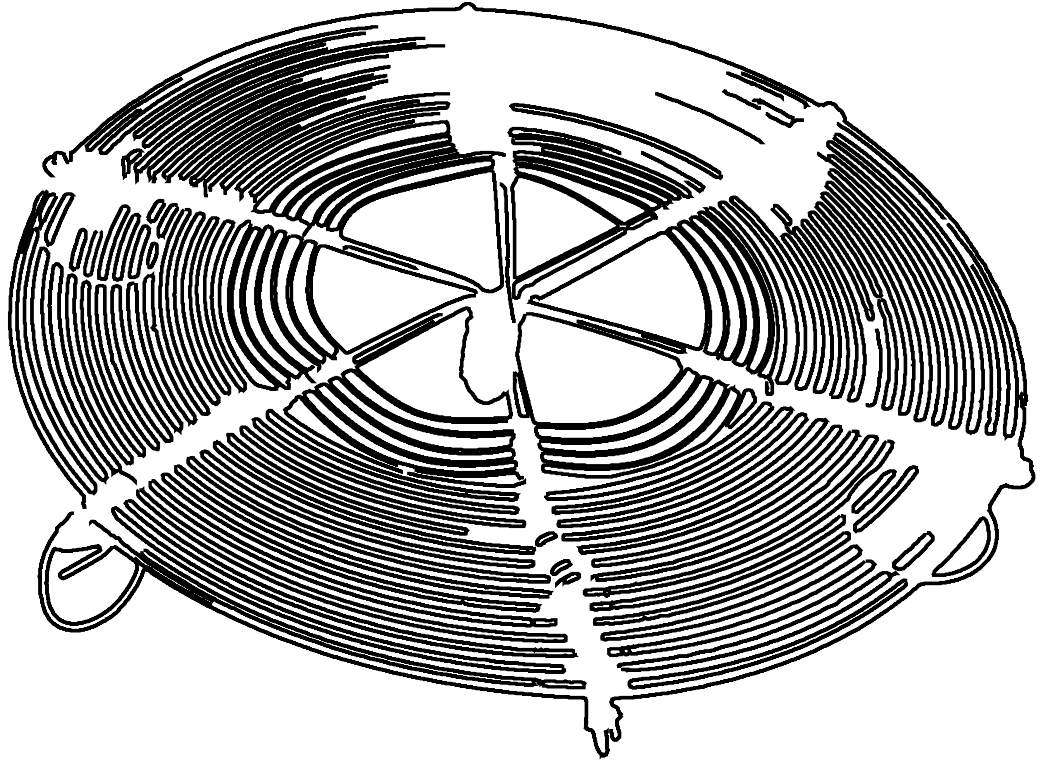
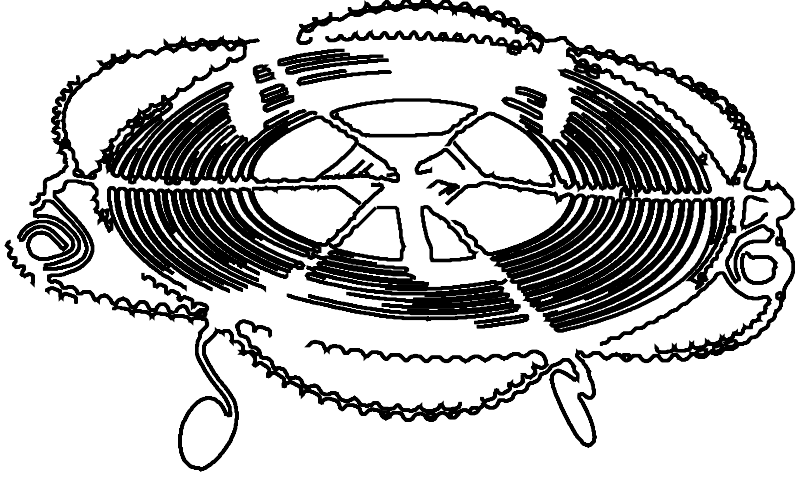
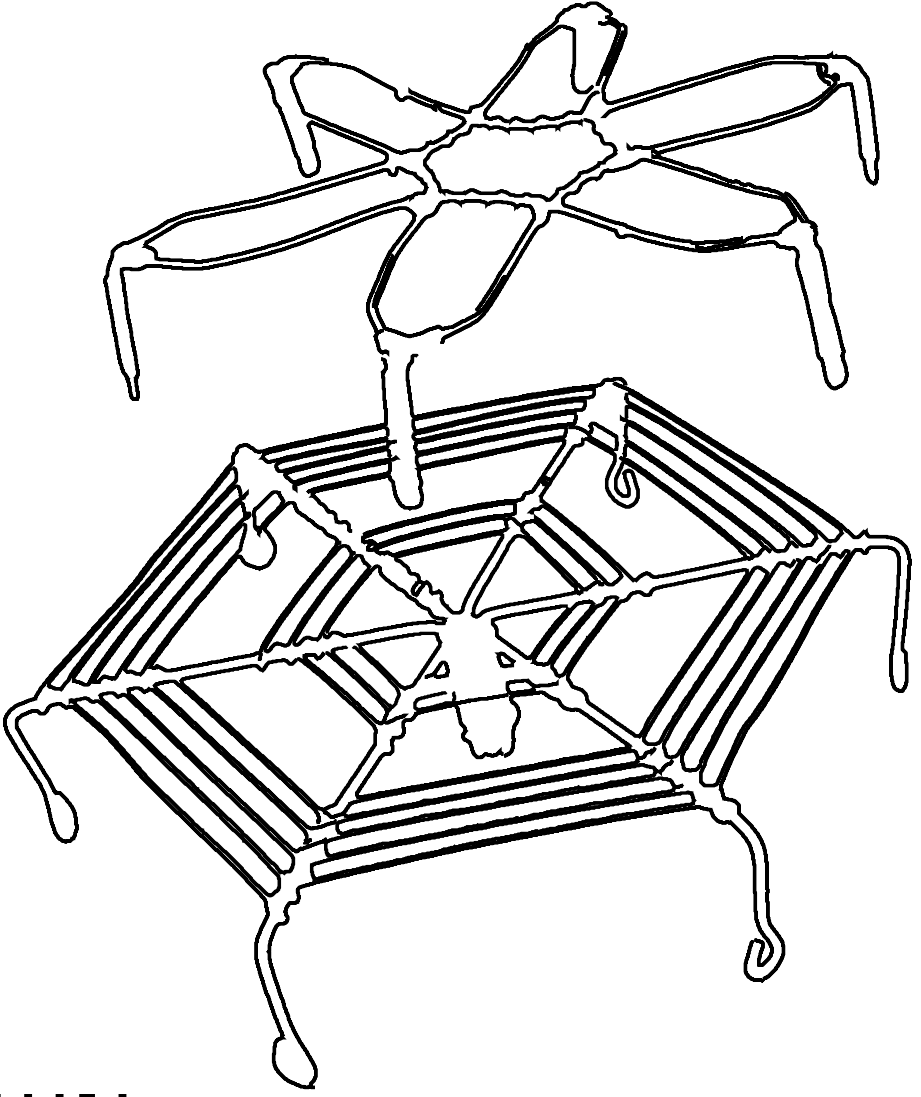

Is it a brain? (19.3%)



Is it a bush? (31.2%)

Is it a bush? (23.5%)

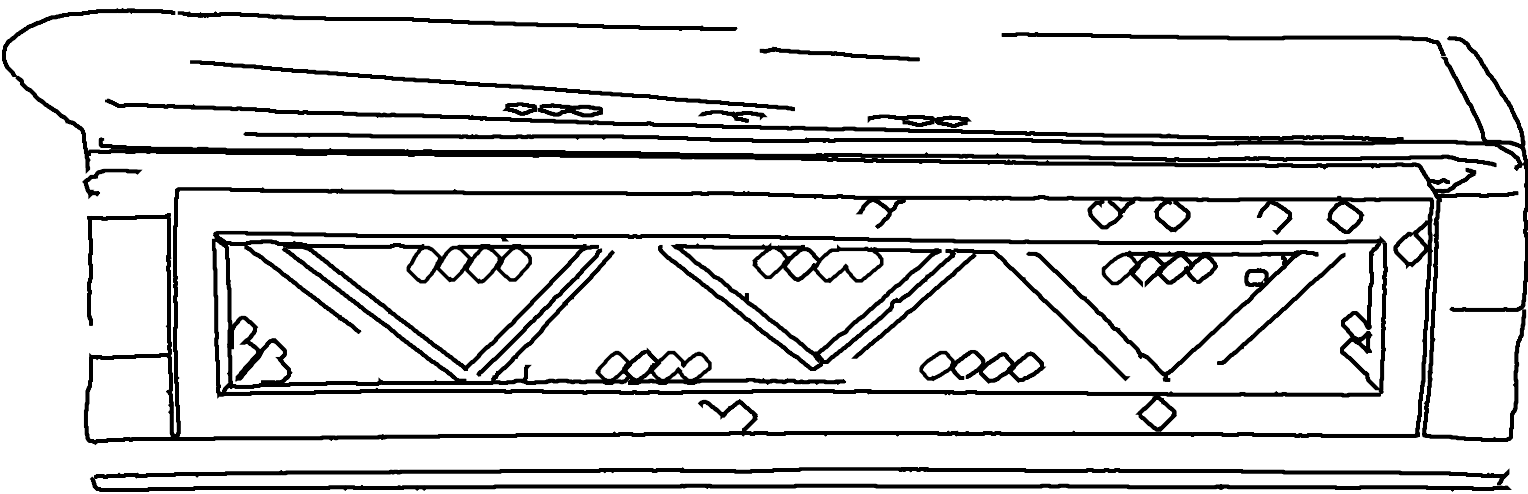

Is it a keyboard? (63.8%)

Is it a skyscraper? (90.5%)

Is it a keyboard? (86.2%)

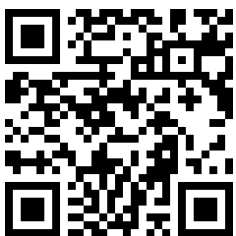

Is it a skyscraper? (96.5%)

Is it a keyboard? (51.8%)

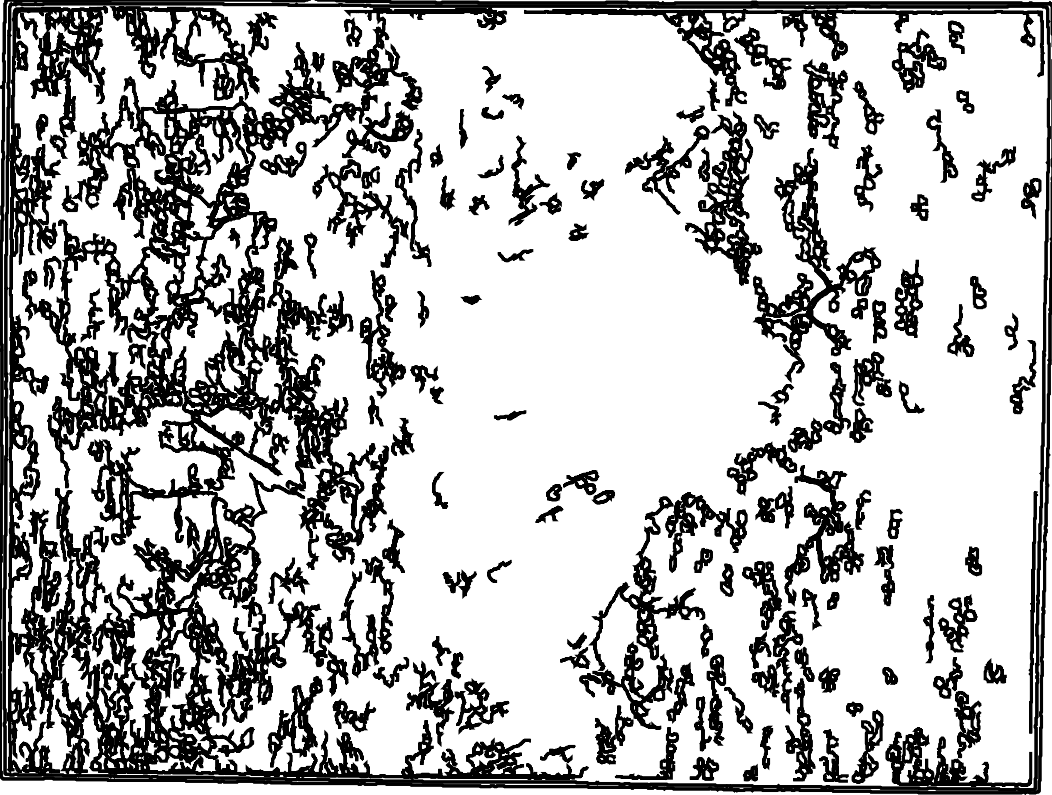

Is it a keyboard? (32.8%)

Is it a keyboard? (35.7%)

Is it a keyboard? (50.4%)

Is it a grapes? (12.8%)

Is it a grapes? (12.4%)

Is it a chandelier? (9.5%)

Is it a grapes? (1.0%)

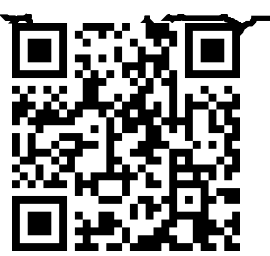

Is it a bush? (11.8%)

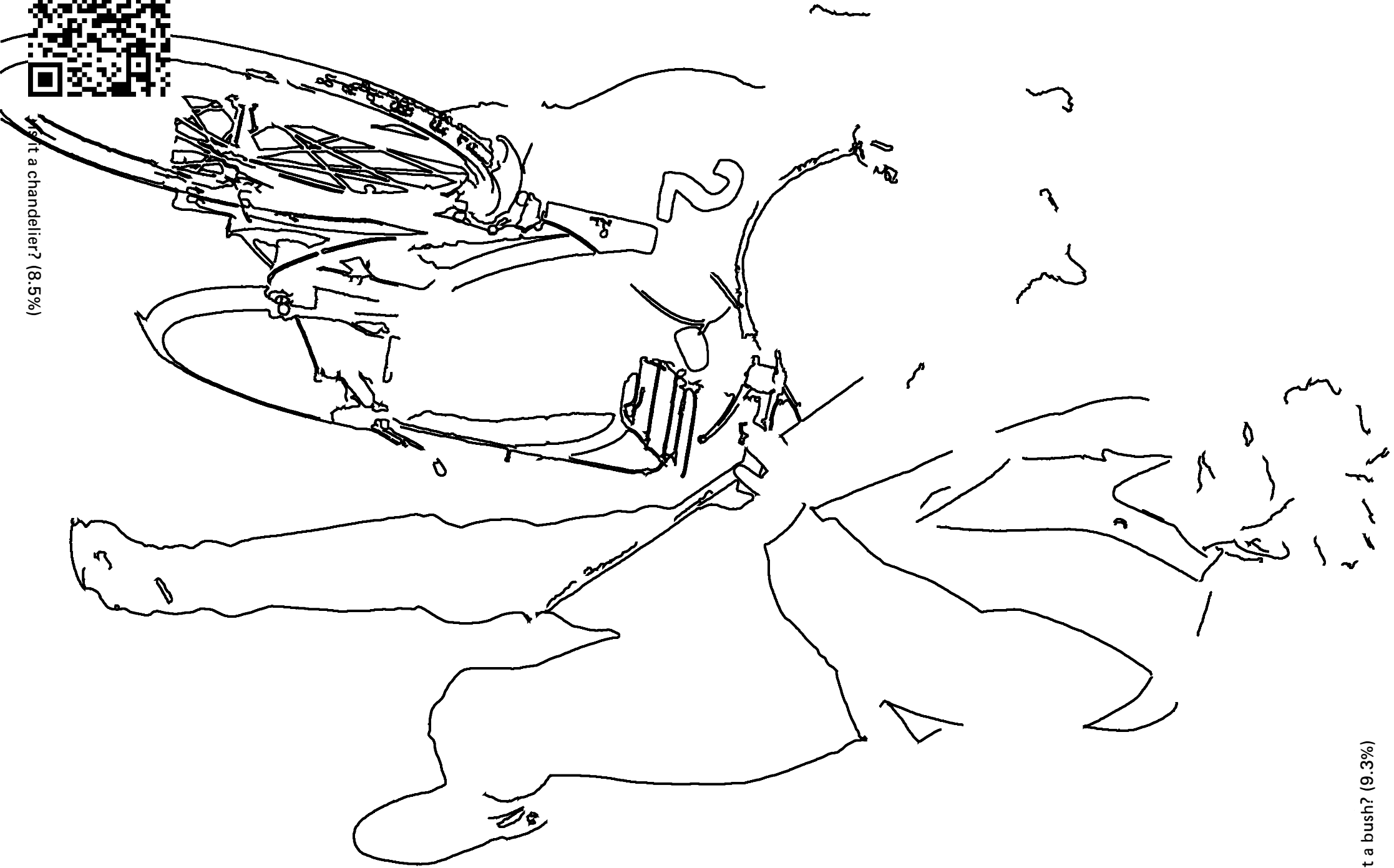

Is it a chandelier? (8.5%)

Is it a chandelier? (4.5%)

Is it a bush? (9.3%)



Is it a keyboard? (33.8%)

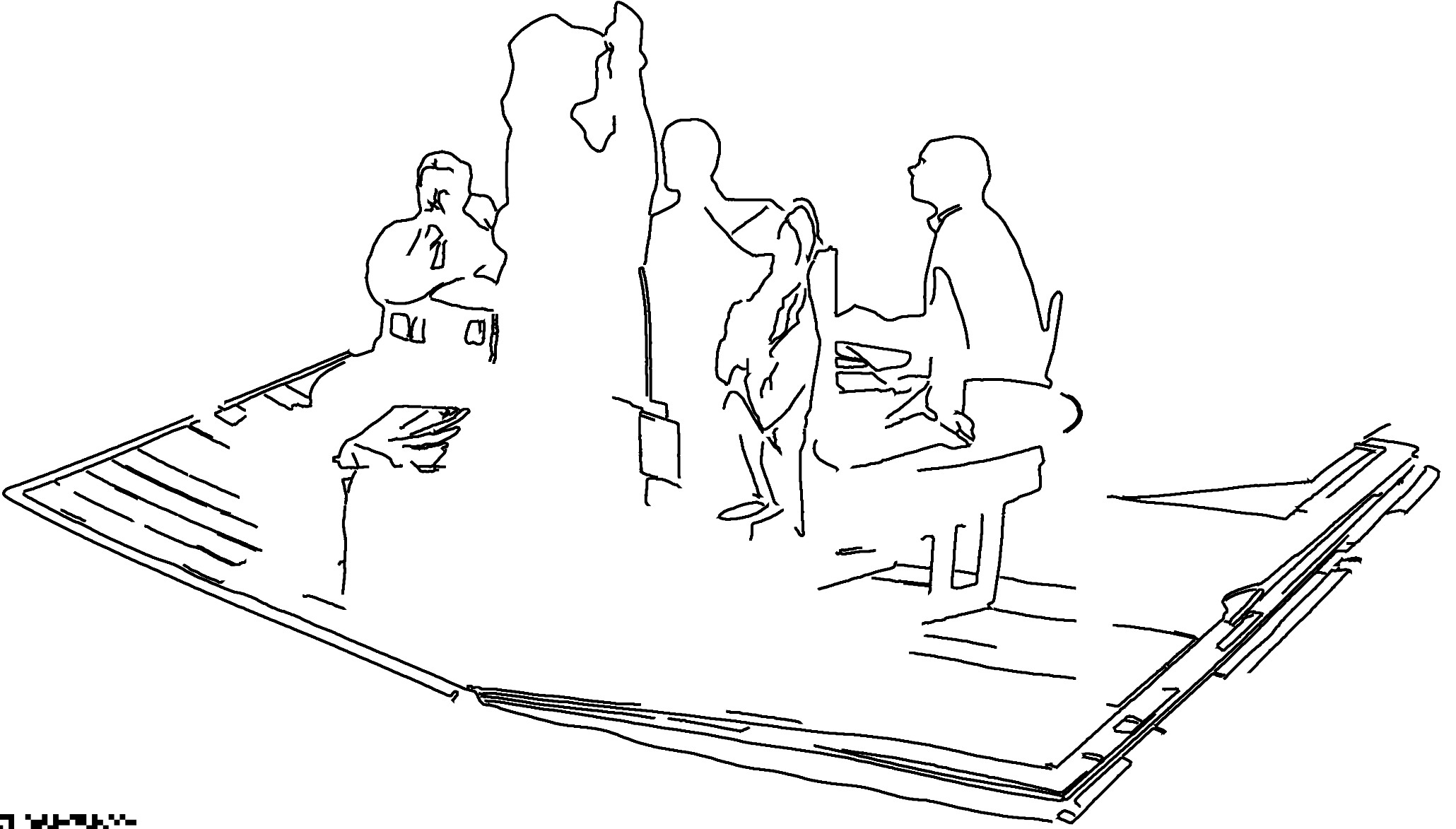

Is it a keyboard? (28.0%)

Is it a keyboard? (15.0%)

Is it a grapes? (16.1%)



Is it a train? (44.1%)



Is it a ladder? (18.8%)

Is it a bush? (21.4%)

Is it a ladder? (16.9%)

Is it a bush? (34.8%)

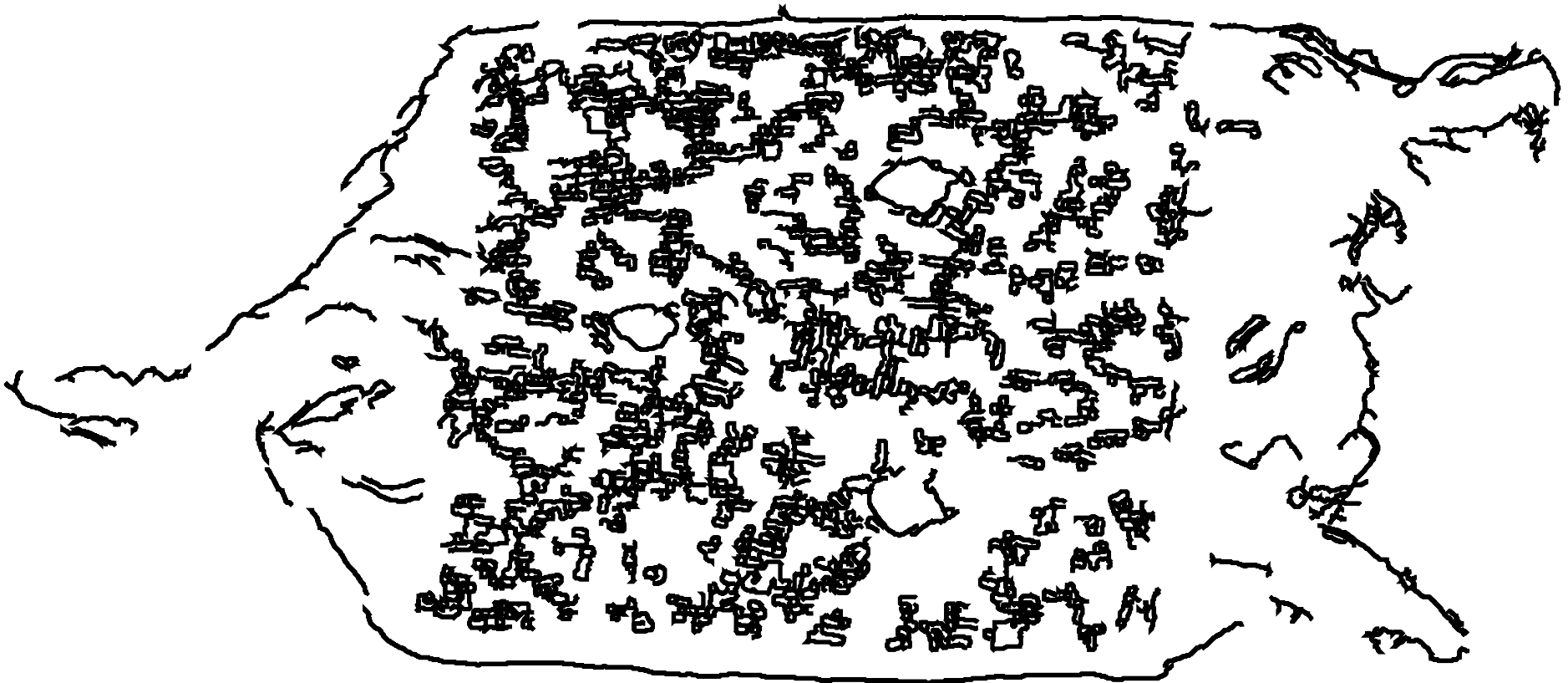

Is it a chandelier? (39.5%)



Is it a bush? (37.7%)

Is it a bush? (14.9%)

Is it a Keyboard? (40.4%)

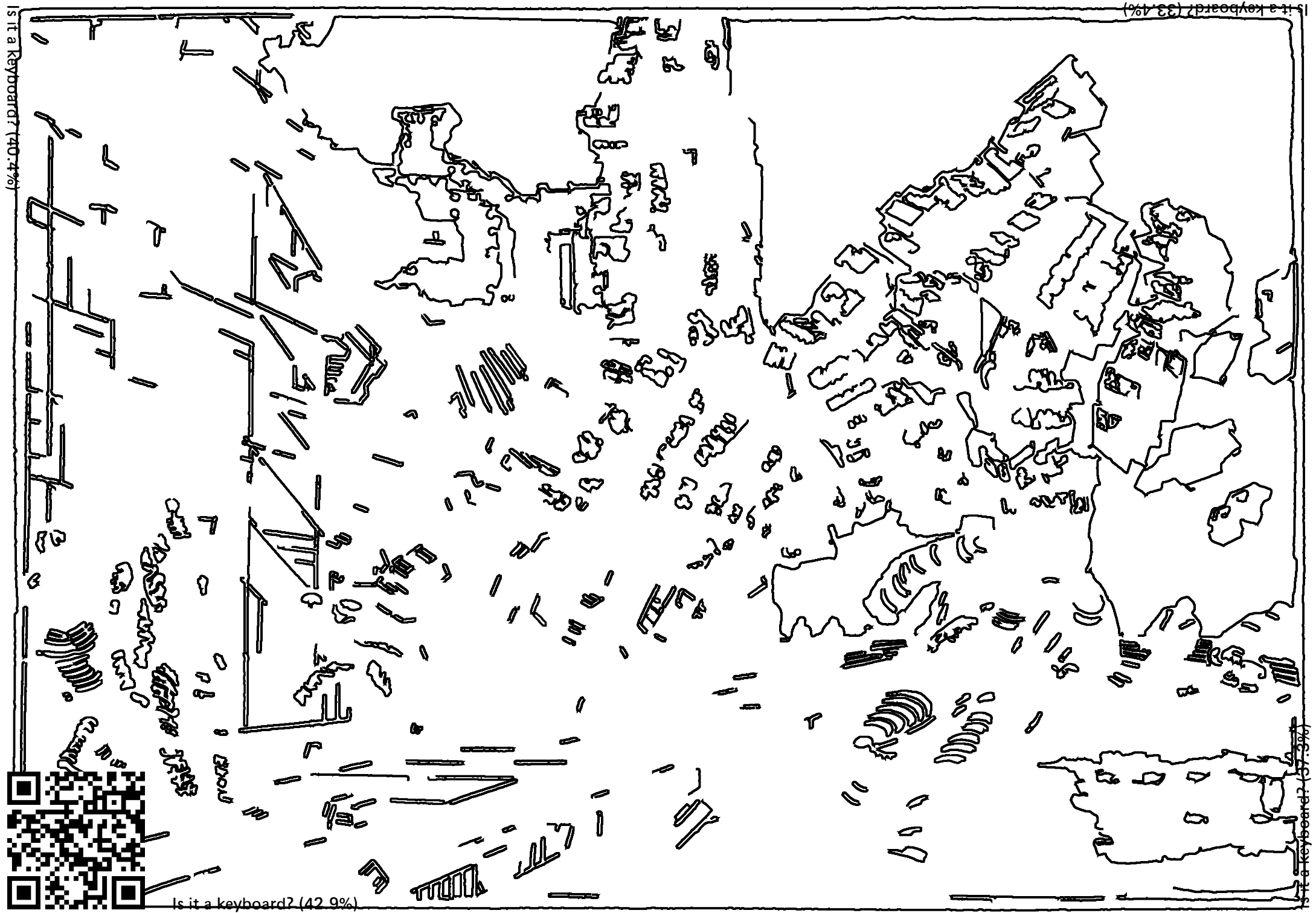

Is it a keyboard? (33.4%)

Is it a keyboard? (37.3%)



Is it a keyboard? (42.9%)



Is it a cactus? (20.2%)

Is it a keyboard? (54.8%)

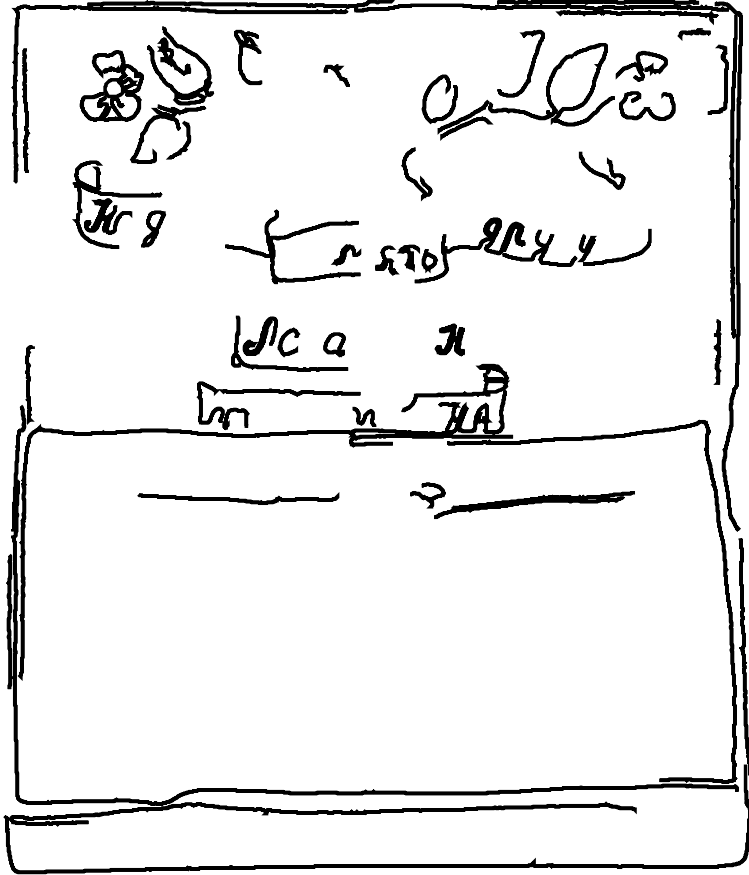

Is it a calculator? (51.0%)

Is it a keyboard? (81.0%)

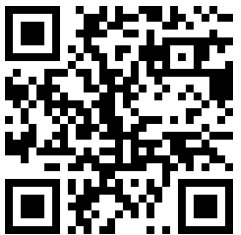

Is it a bush? (41.4%)

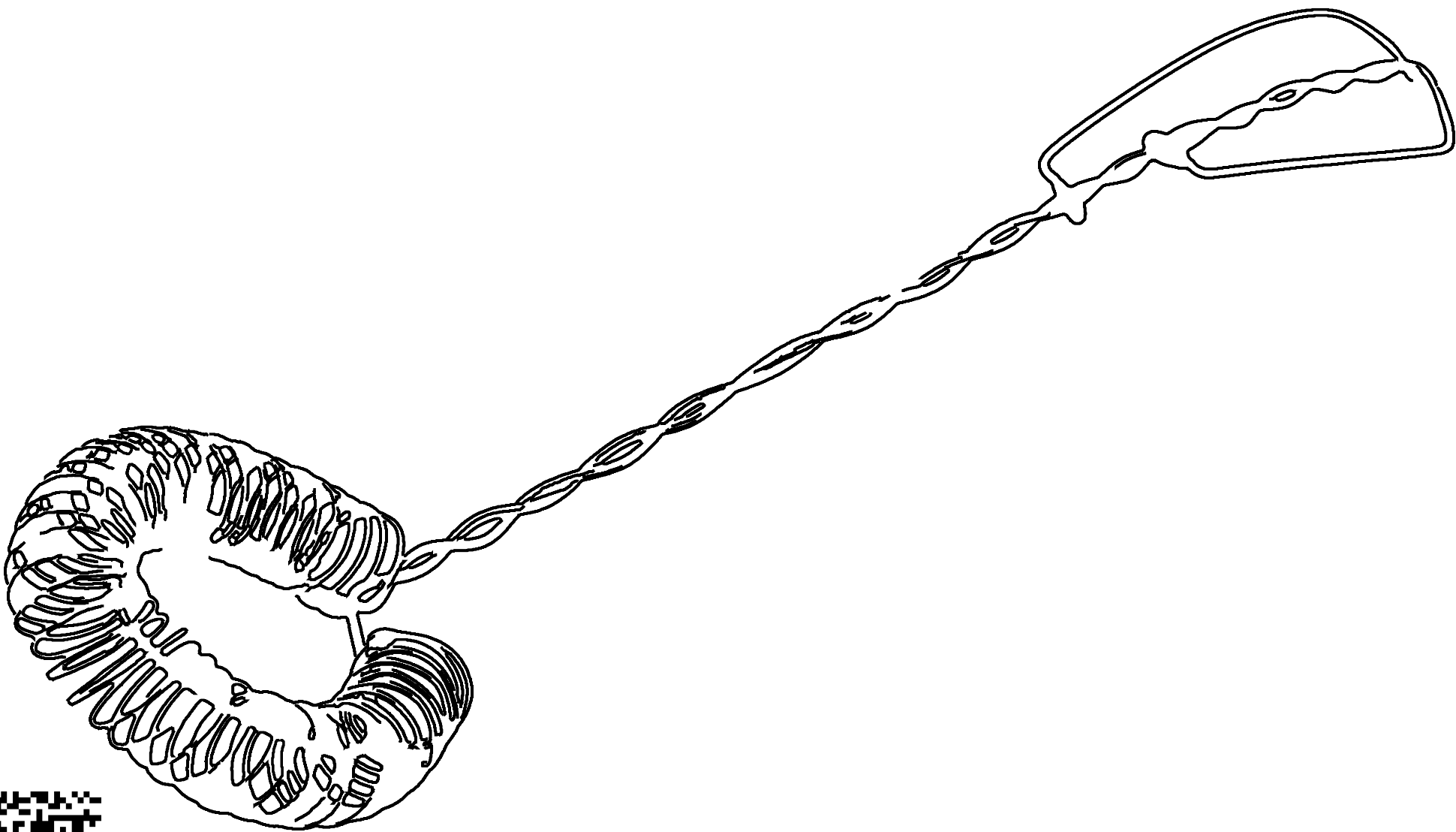

Is it a bush? (61.6%)

Is it a toothbrush? (53.1%)

Is it a bush? (59.3%)

Is it a chandelier? (4.7%)

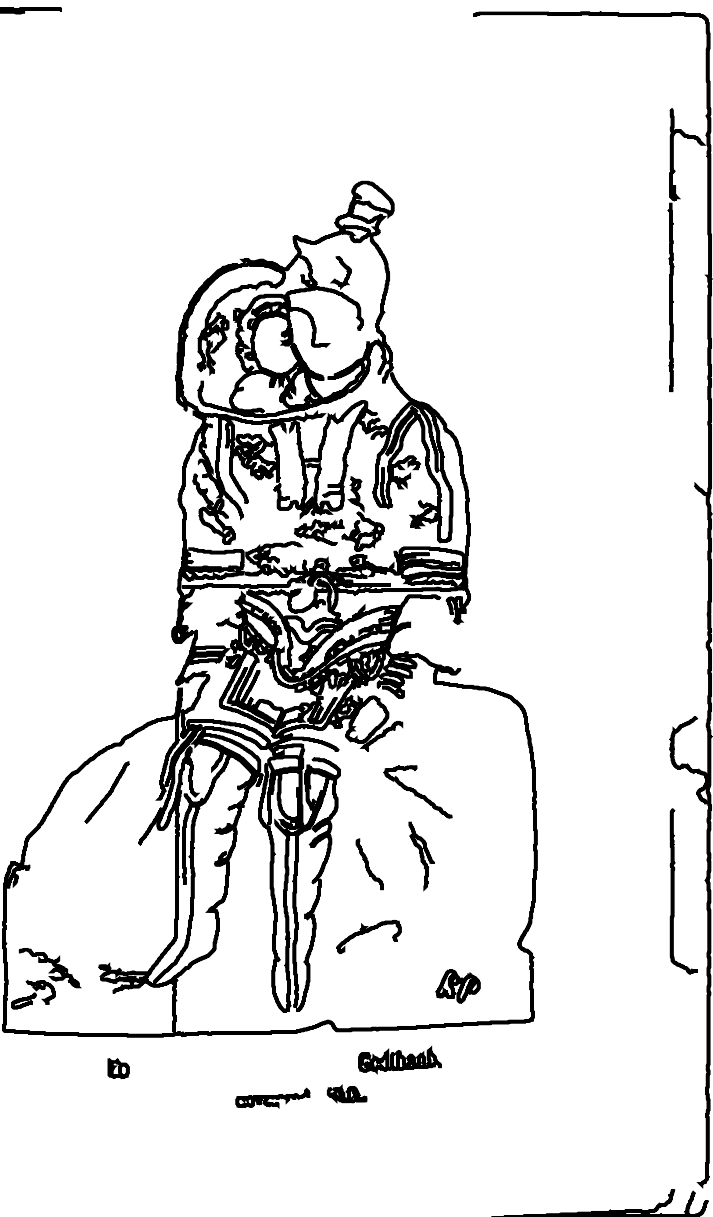

Is it a bush? (16.4%)



Is it a chandelier? (8.6%)

Is it a keyboard? (6.9%)





Is it a cell-phone? (23.0%)

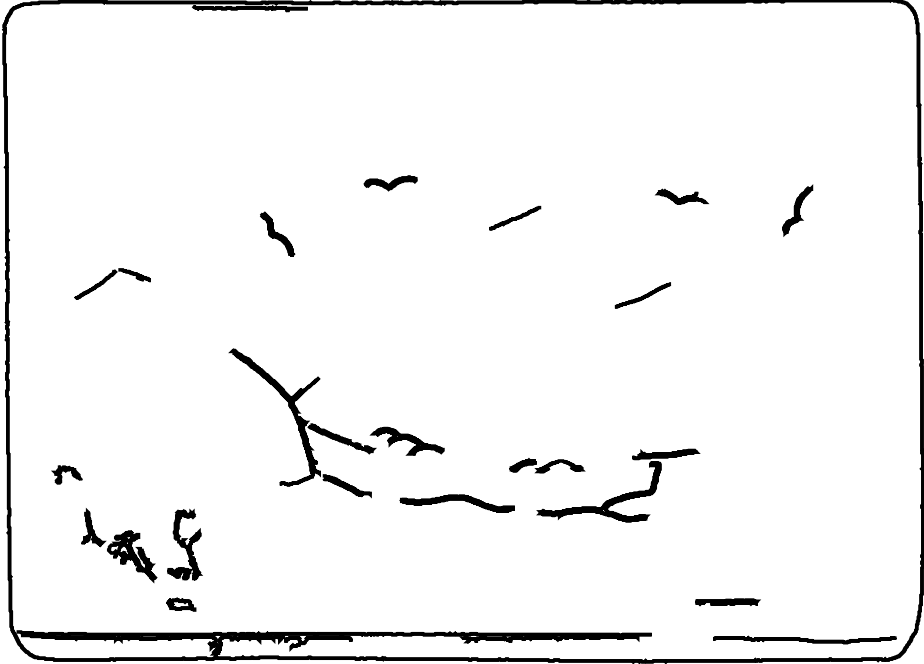

Is it a cell-phone? (23.0%)

Is it a telephone? (18.8%)

Is it a calculator? (18.2%)



Is it a cactus? (64.4%)

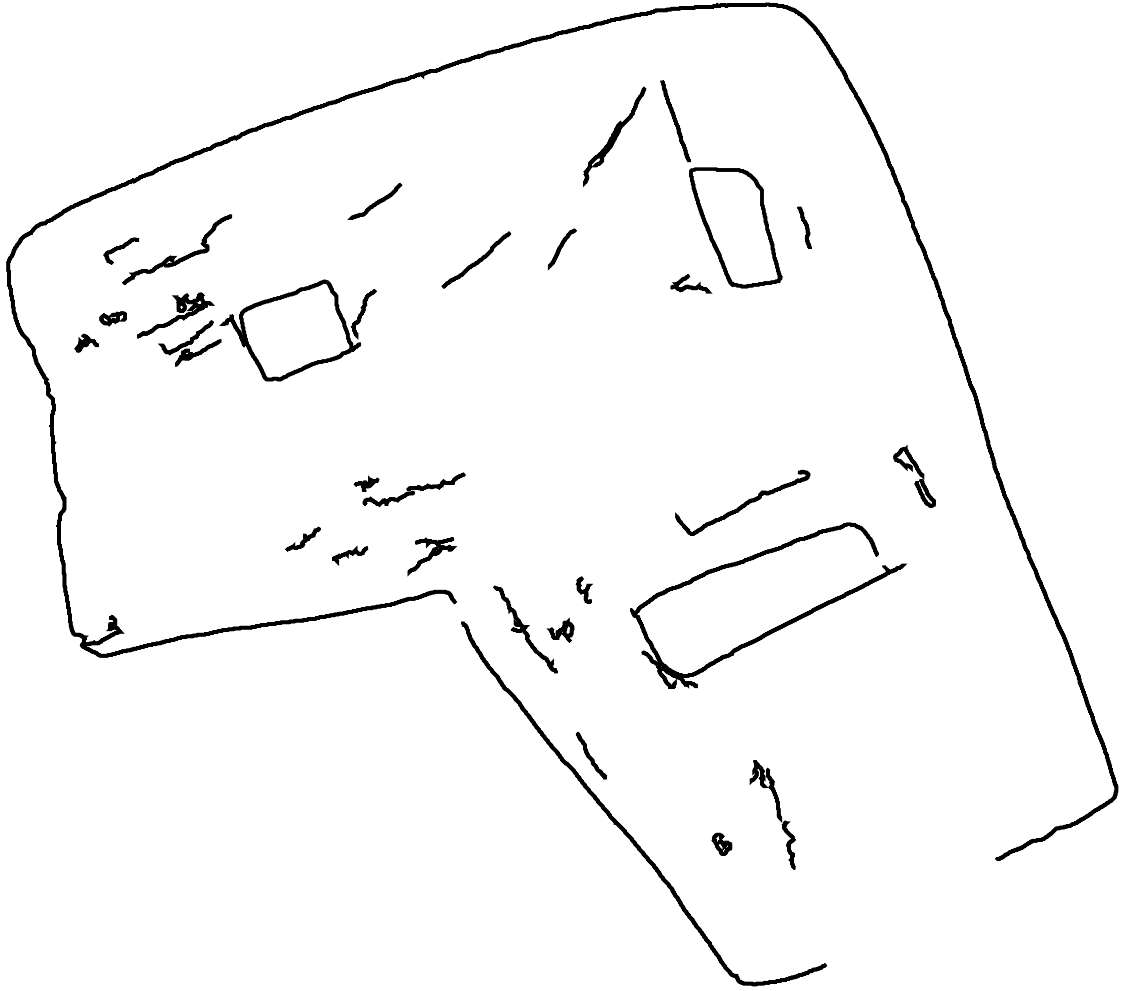

Is it a keyboard? (20.9%)

Is it a strawberry? (47.8%)

Is it a keyboard? (37.8%)

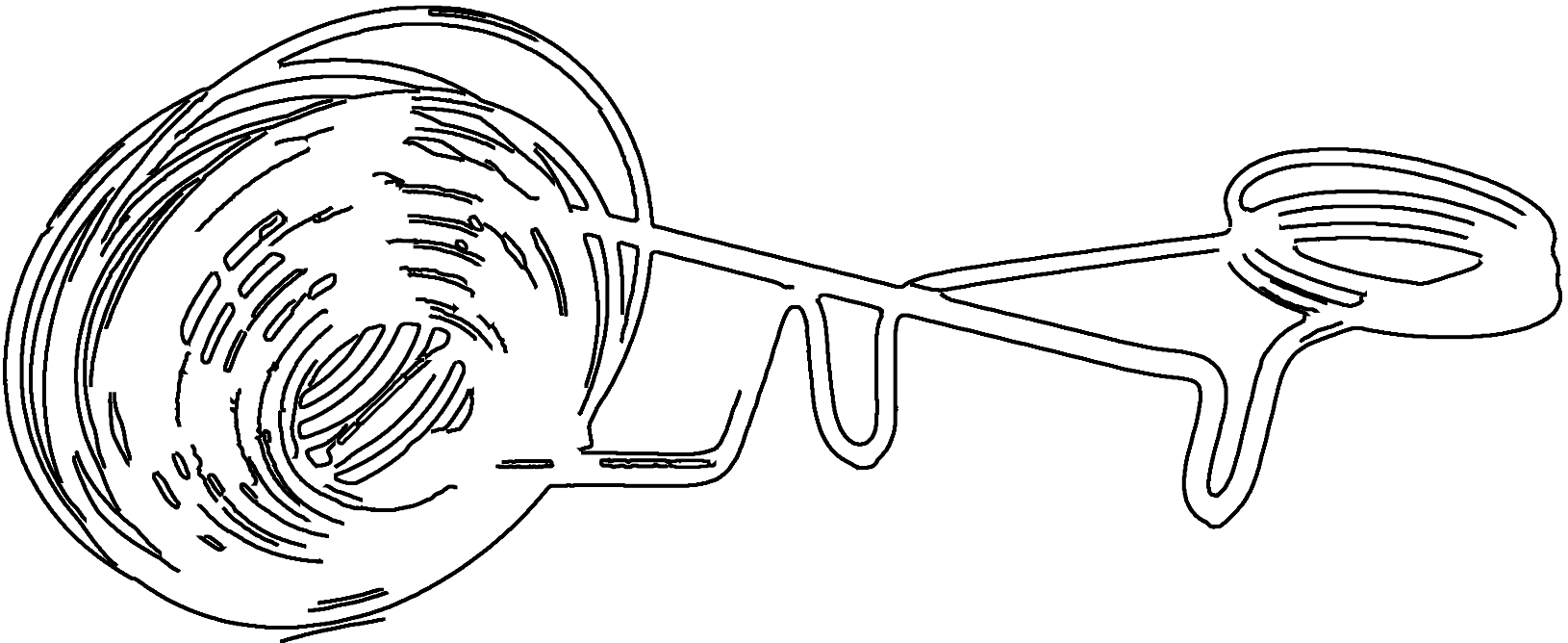

Is it a bush? (54.5%)

Is it a bush? (44.8%)

Is it a bush? (55.5%)



Is it a pineapple? (33.3%)

Is it a keyboard? (31.2%)

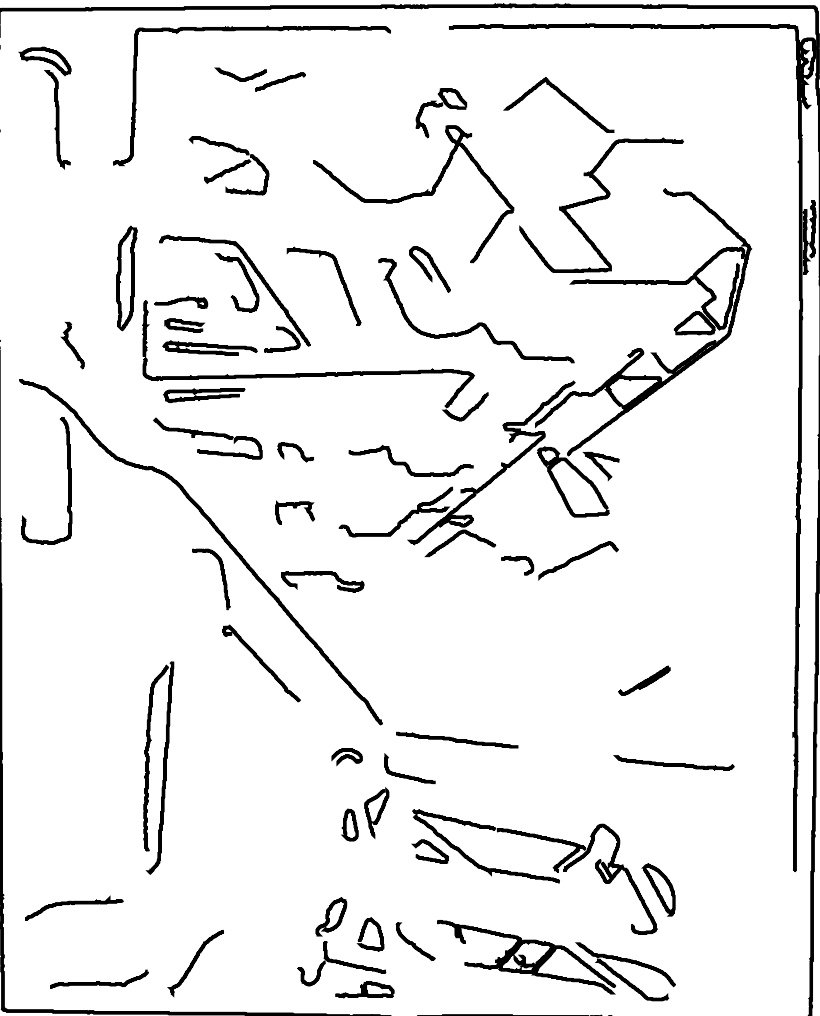

Is it a keyboard? (73.0%)

3

ооо	оо	не	пук	н	рк	Сна	рш	пу	н	оуе	Сч	оуе
ннук	р	е	у	с	н	о	н	у	р	о	а	шнна
ш		ссф										



Is it a keyboard? (70.1%)

Is it a skyscraper? (26.8%)



Is it a keyboard? (9.6%)

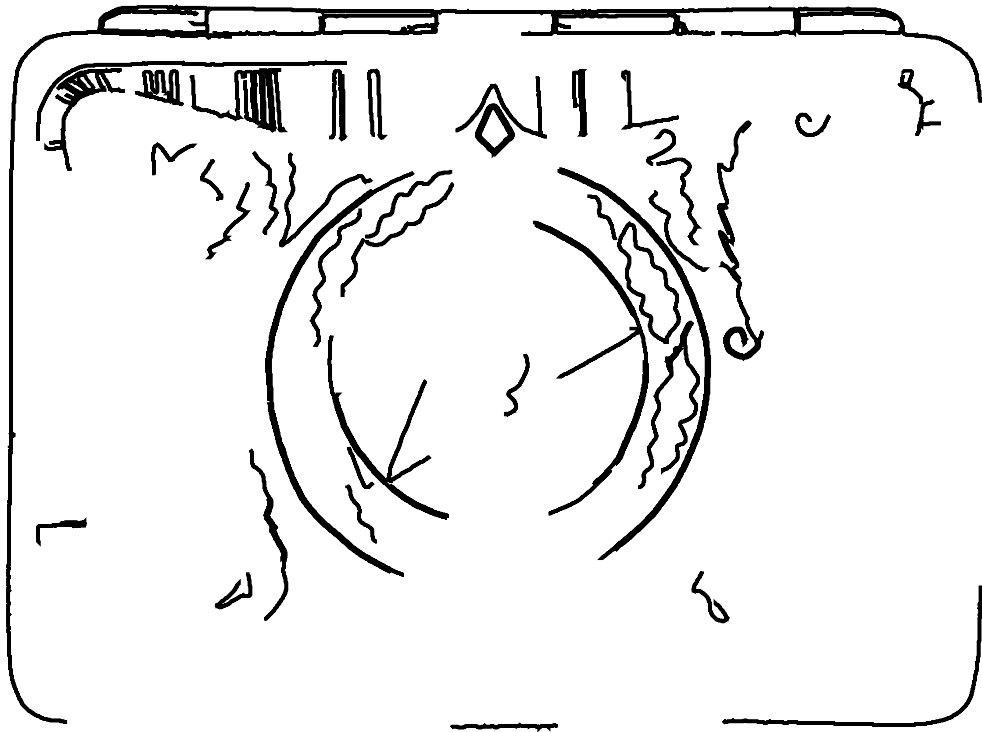

Is it a keyboard? (10.1%)

Is it a keyboard? (14.5%)

Is it a keyboard? (9.0%)

1
 f u m a s n
 to n m m f
 see m l h b l l e s a m b
 x b a d t n i t e b r
 g a h y a p e t e
 l a o f b r e h f p r o n o r
 a n a t e t e l a s a g d o r r o t ?
 u m r g g u w t h e e d
 l / u l n e t b e u w e d t h e u l e f t h
 r e f r e e r e d o f f t e n o v a z
 g h u u o n t h e n e t o f p e n t h e n J u a h l
 u h g n d a n d y e o f f r e t a o u t o f
 e a t e a n d a t h l e s a f f
 a d e h t ? f h
 t o n e d s i u t a n t e w e t e
 a f o
 u t r o o t f n e n o f u g
 t e n o n p e h e o f t

H^r Suh v⁷ 0 a s l a
 1 b e l g r a r g n d m e s
 b e l b y t w o f u l a h

M Sm l n s e t h e h s d
 o n h u s e f S u l p h u r b u t
 o n a p e r w h c h h p e i s h e d
 I t r e a d s s f ? s
 C l e a n t h e P l a w i t h S p i r i t
 o f W n a n d p o l i s h w i t h
 s o f t C o t t o n
 U s i n g c a m e l h a i r p e n I
 p a s s i n g i t t h r o u g h
 t h e l i g h t e s t p a r t T h e n u i l
 t h e v e r y S u l p h u r d u s t t h e
 w h i t e p a r t a n d l e a v e t
 s i d e f o r t w o m o u n t s
 u n d e r t h e O i l h a s t e g u n t
 2 r l e n





Is it a bush? (28.4%)

Is it a bush? (16.5%)



Is it a bush? (9.4%)

Is it a bush? (21.1%)



Is it a bush? (56.0%)

Is it a bush? (34.6%)



Is it a bush? (22.0%)

Is it a bush? (58.2%)

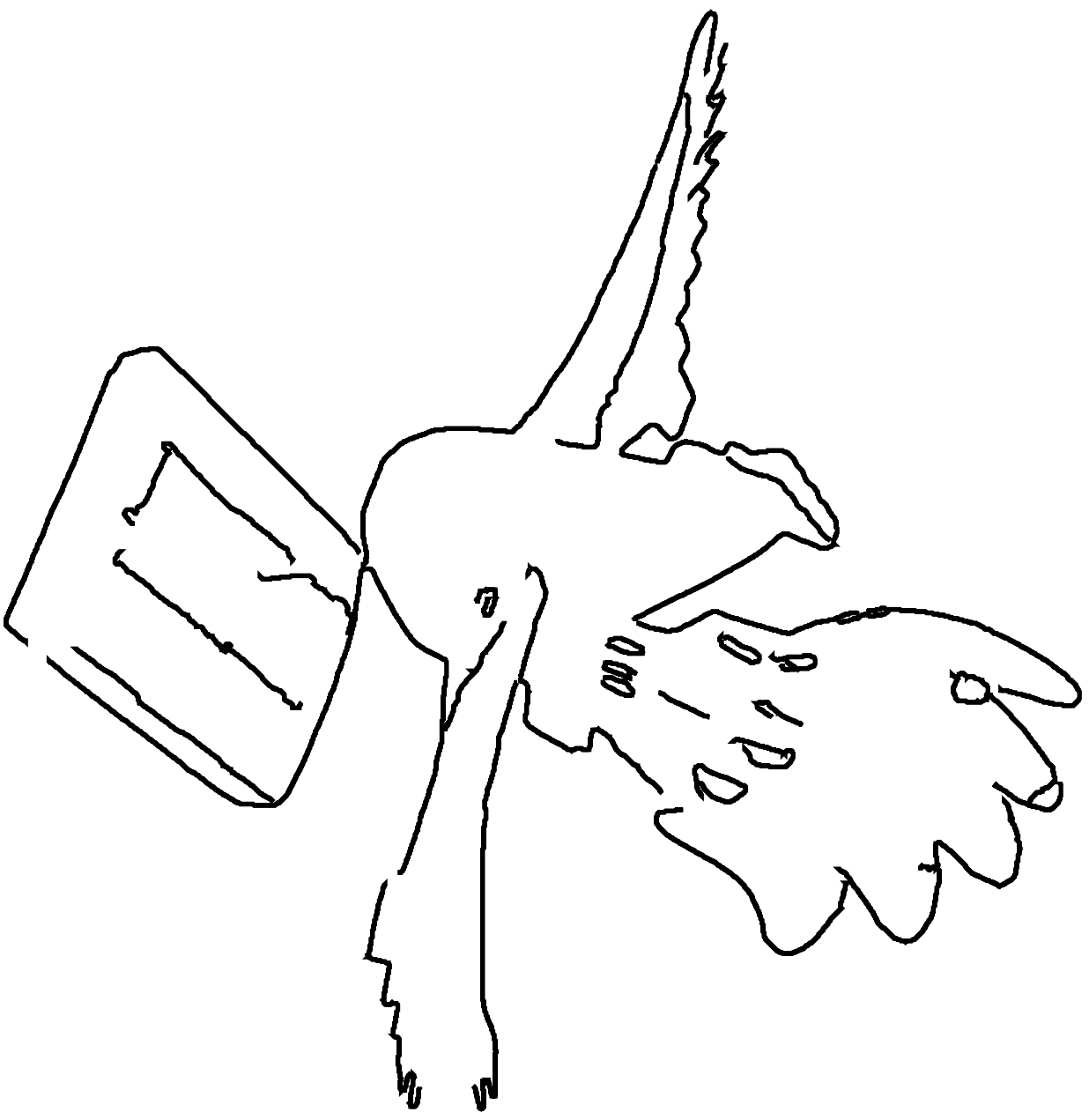

Is it a bush? (22.6%)

Is it a cactus? (25.5%)

Is it a skyscraper? (21.4%)

Is it a cactus? (42.2%)





Is it a cactus? (95.7%)



Is it a bush? (66.2%)

Is it a cactus? (97.1%)

Is it a bush? (56.9%)

Is it a bush? (58.9%)

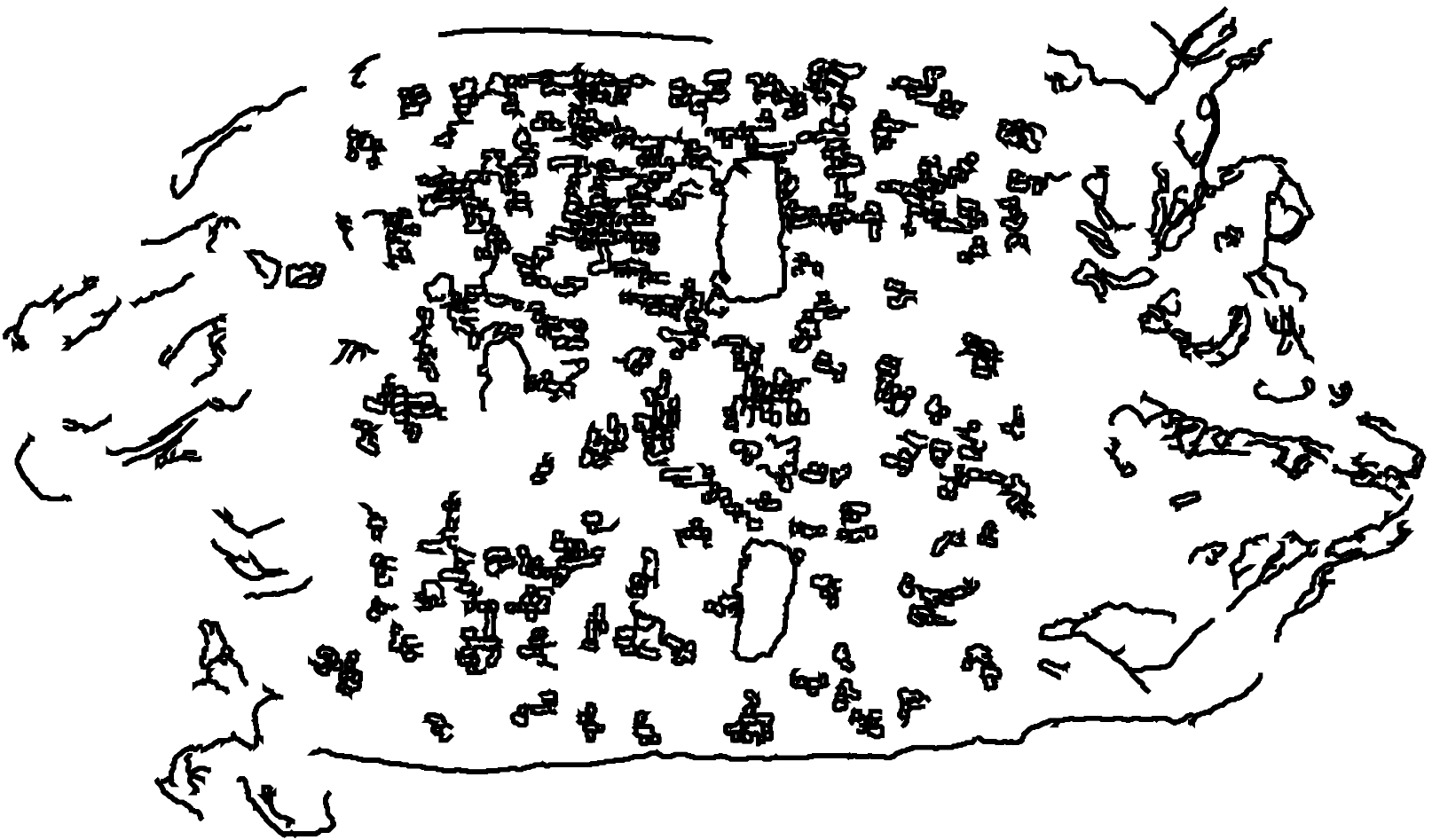

Is it a grapes? (20.2%)



Is it a bush? (12.4%)

Is it a bush? (39.3%)



Is it a toothbrush? (65.5%)

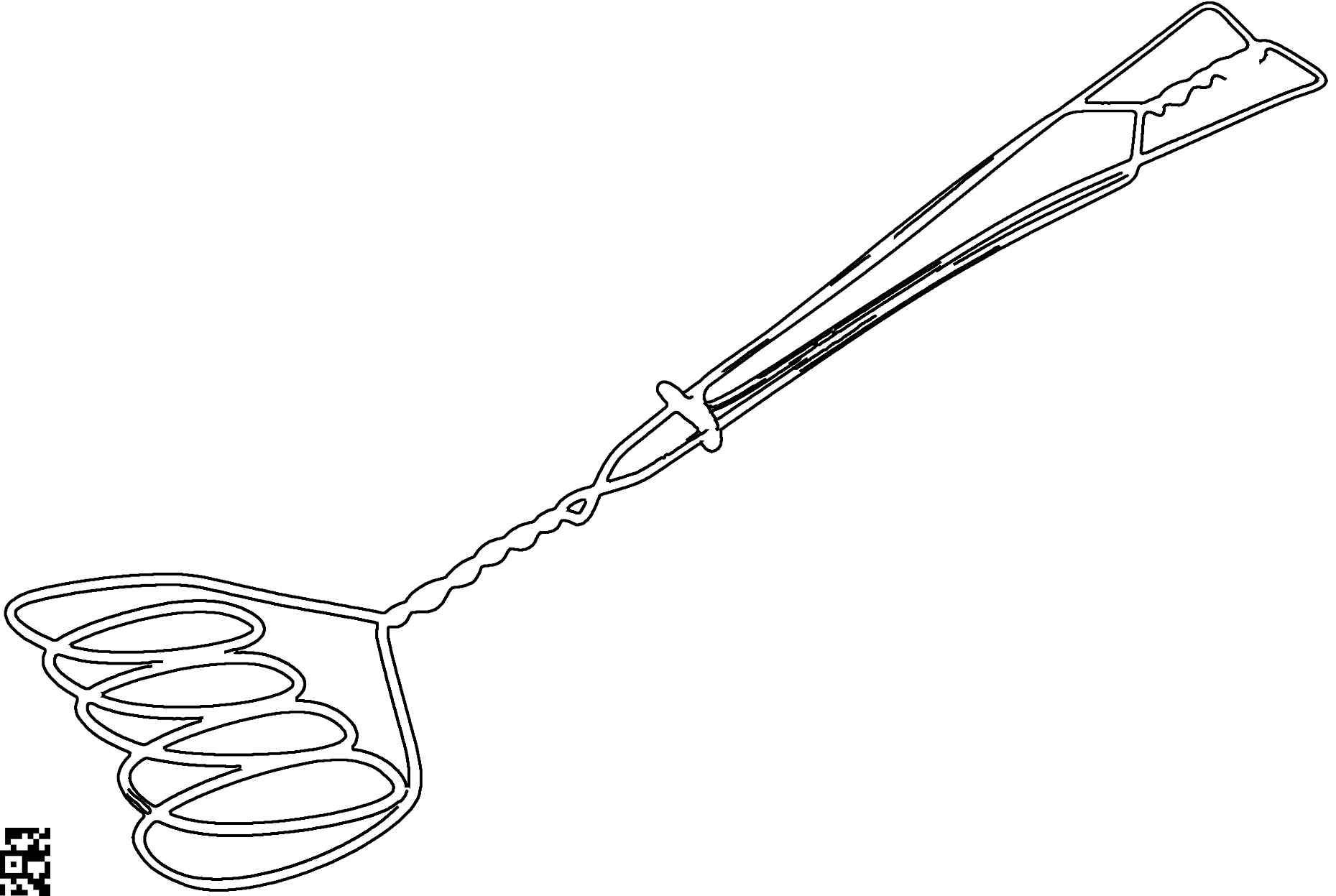

Is it a toothbrush? (93.9%)

Is it a toothbrush? (98.3%)

Is it a toothbrush? (95.8%)



Is it a skyscraper? (54.9%)

Is it a keyboard? (61.6%)

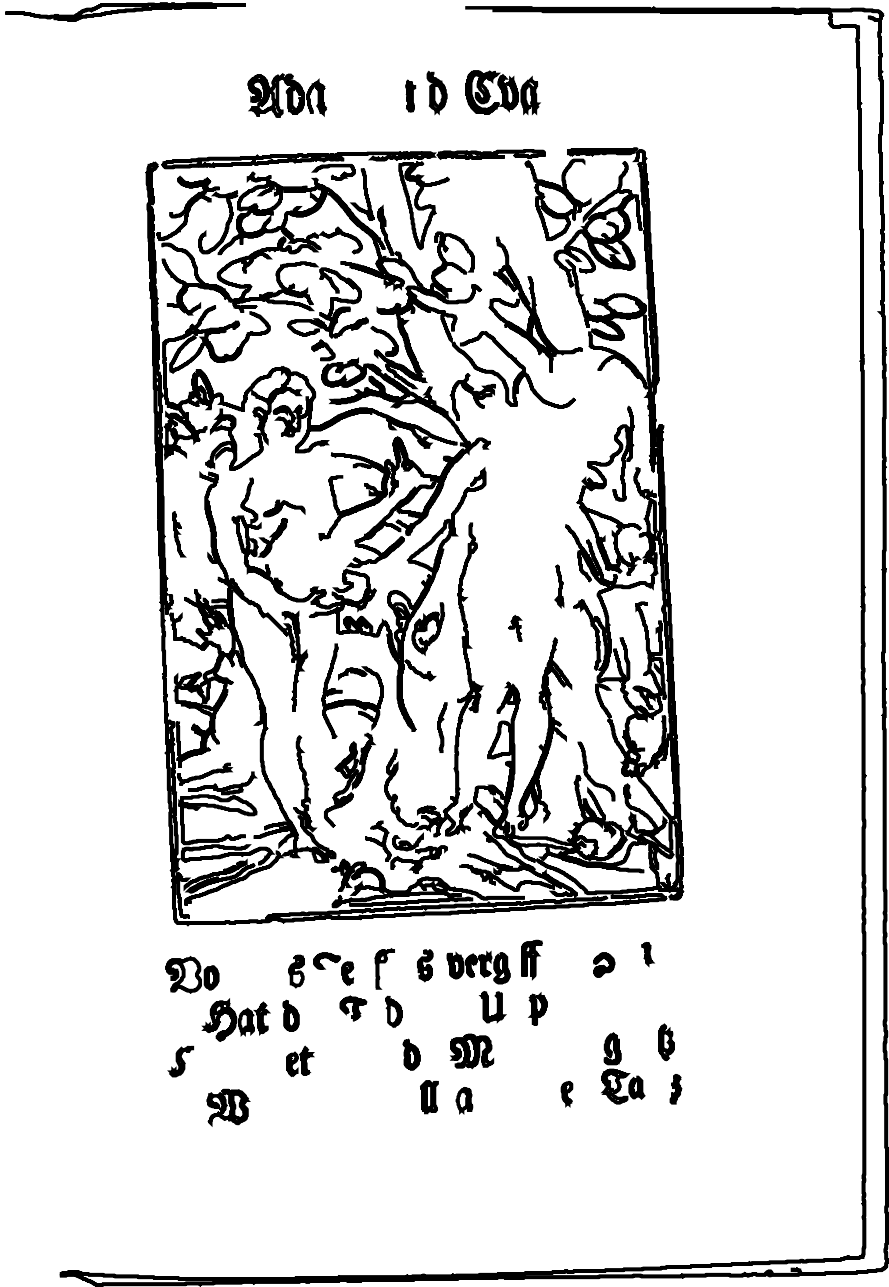

Is it a keyboard? (88.8%)

Is it a skyscraper? (50.6%)



Is it a calculator? (37.8%)

Is it a calculator? (29.1%)

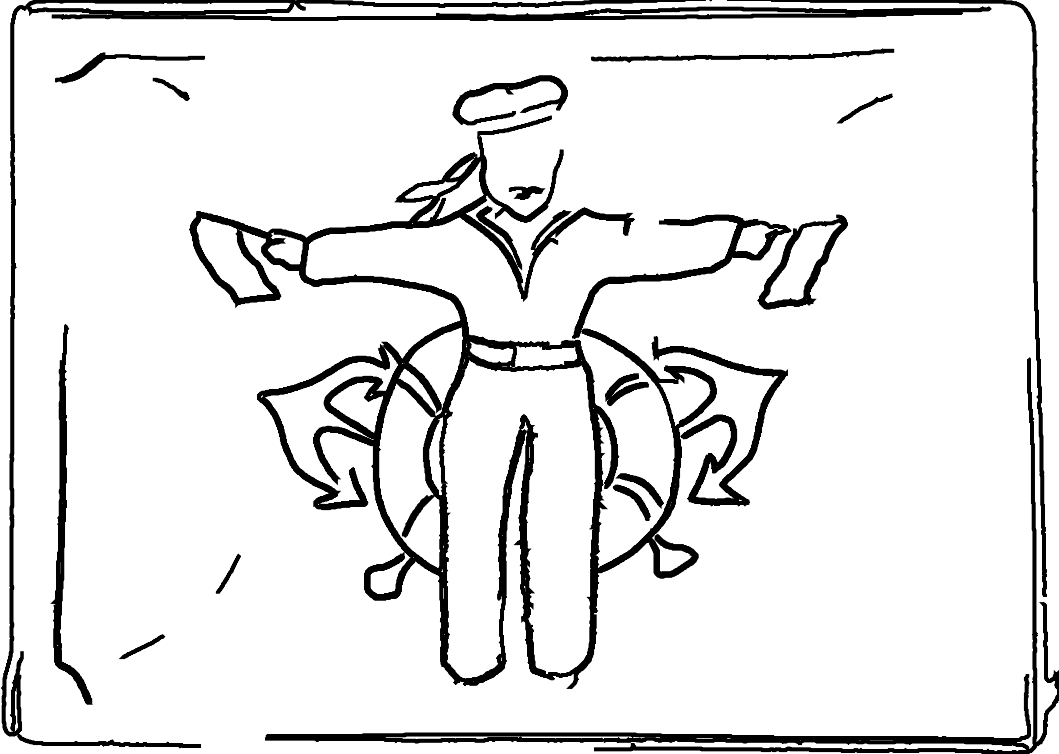

Is it a calculator? (25.4%)

Is it a calculator? (32.7%)

1
The movement into the image, 2
precisely the same as travelling
3 out into the world. 4 It is a question
of seeing 5 through the conventions,
6 of seeing 7 one's own culture
the outside — or of trying to go
8 as far as possible 9 into it.

GUTTORM GUTTORMSGAARD